



G3 *Boats*[®]
YAMAHA BOAT COMPANY

OWNER'S MANUAL

FUEL SYSTEMS

Boats manufactured for use in California for model year 2018 and after meet the California EVAP Emissions regulation for spark-ignition marine watercraft. Boats meeting this requirement will have the following label affixed near the helm.

WARNING

Operating, servicing and maintaining a recreational marine vessel can expose you to chemicals including engine exhaust, carbon monoxide, phthalates and lead, which are known to the State of California to cause cancer and birth defects or other reproductive harm. To minimize exposure, avoid breathing exhaust, service your vessel in a well-ventilated area and wear gloves or wash your hands frequently when servicing this vessel. For more information go to: www.P65warnings.ca.gov/marine

The fuel system in boats marketed in states other than California complies with U.S. EPA-mandated evaporative emission standards at time of manufacture using certified components.

CALIFORNIA AIR RESOURCES BOARD (CARB)

Outboard, sterndrive and inboard powered boats sold in the state of California are equipped with special components and certified to meet stricter environmental standards and exhaust emissions. All boats sold in California since 2009 are required to meet Super-Ultra-Low (four-star) emissions.

EXHAUST EMISSIONS



Sterndrive and inboard marine engine powered boats meeting CARB's exhaust emission standards are required to display the four-star label on the outside of the hull above the waterline. Outboard and personal watercraft marine engines may also comply with these standards.

DANGER

Carbon monoxide (CO) can cause brain damage or death. Engine and generator exhaust contains odorless and colorless carbon monoxide gas. Carbon monoxide will be around the back of the boat when engines or generators are running. Signs of carbon monoxide poisoning include nausea, headache, dizziness, drowsiness and lack of consciousness. Get fresh air if anyone shows signs of carbon monoxide poisoning. See engine manufacturer's manual for information regarding carbon monoxide poisoning.

TABLE OF CONTENTS

Introduction	1-1
About This Manual	1-1
About Your New Boat.	1-2
Boat Terminology	1-2
Hull Identification, Capacity and Safety Plates	1-3
Design Category	1-4
Disclaimer	1-4
References and Contact Information	1-5
Boat Information Form	1-8
Safety	2-1
Safety Information	2-1
Limitations On Who May Operate The Boat.	2-2
Good Boating Practices	2-2
Boat Setup	2-5
Safety and Training.	2-6
Strong Points.	2-6
Safety Labels.	2-6
Safety Statements.	2-7
Safety Precautions	2-8
Required Boating Safety Equipment and Regulations.	2-14
Fire Extinguisher	2-16
Engine Emergency Stop Switch and Lanyard.	2-16
Life Jackets	2-17
Visual Distress Signaling (VDS) Devices	2-22
Audible Signaling Devices.	2-25
Navigational Lights	2-25
Recommended Safety Equipment	2-27
Very High Frequency (VHF) Radio.	2-28
Personal Location Beacon (PLB).	2-29
Situational Awareness	2-29
Driving Defensively	2-29
Small Boats and Swimmers	2-30
Knowing the Boat	2-30
Special Needs Passengers.	2-30
Cruising Limitations	2-31
Hazard Information.	2-32



TABLE OF CONTENTS

Water Sports	2-32
Platform Dragging.	2-33
Water Sports Guidelines.	2-34
Boating Regulations and Your Responsibilities	3-1
Boat Owner / Operator Responsibilities	3-1
Safety	3-1
Registration	3-2
Insurance	3-2
Reporting Accidents.	3-2
Boating Under the Influence.	3-3
Operator's License and Education.	3-3
Operation By Minors.	3-3
Emergency Assistance	3-4
Negligent Operation	3-4
Restricted Areas	3-5
America's Waterway Watch	3-6
Fishing	3-6
Wake.	3-7
Noise.	3-7
Speed	3-7
Shallow Water Boat Stability	3-7
Protecting the Environment	3-8
Aquatic Invasive Species (AIS)	3-8
Paints	3-9
Cleaning Agents	3-9
Exhaust Emissions	3-10
Emergencies	4-1
First Aid / Medical Emergencies	4-1
Emergency Preparation Checklist	4-1
Using Distress Signals.	4-1
Requesting Assistance (Non-Distress Call)	4-2
Fire and Explosion	4-3
Man Overboard (MOB).	4-4
Capsizing and Flooding	4-5
Running Aground.	4-5
Dangerous Weather	4-6
Engine or Boat System Failure	4-6



Accidents, Collisions and Giving Assistance	4-6
Towing on the Water	4-7
Law of Salvage	4-8
Hurricane and Severe Weather Preparedness	4-9
Protecting the Boat from Theft	4-9
Operating in Hazardous Conditions	5-1
Severe Weather	5-1
Storm Conditions	5-1
Fog Conditions	5-2
Reduced Visibility	5-2
Cold Weather	5-2
Water Hazards	5-2
Aquatic Vegetation / Weeds	5-3
Dams and Spillways	5-3
Shallow Water Operation	5-3
Markers, Warnings and Advisories	5-4
Boat Flags	5-4
Harbor Flags and Indicators	5-5
Navigation Rules and Aids	6-1
Rules of the Road	6-1
Right-of-Way	6-1
Crossing	6-2
Meeting Head-On	6-3
Overtaking / Passing	6-4
Audible Signals	6-4
Aids to Navigation	6-5
Buoys	6-5
Daymarks / Dayboards	6-6
Lights and Lighted Structures	6-7
Markers	6-8
Navigational Lights and Night Operation	6-13
Operating the Boat	7-1
Before Getting Underway	7-1
Safety Equipment	7-1
Float Plan	7-1
Pre-Departure Safety Checklist	7-2
Boarding	7-3



TABLE OF CONTENTS

Boat Loading	7-4
Fueling	7-5
Fuel Management	7-5
Fuel Suppliers	7-5
Static Electricity and the Fuel System	7-5
Fuel (Gasoline)	7-6
Before Refueling	7-8
Refueling	7-8
Refueling Built-In Fuel Tanks	7-9
After Refueling	7-9
Outboard Engine Fueling Considerations	7-9
Getting Underway	7-10
Starting	7-10
Steering	7-11
Shifting	7-12
Stopping	7-12
Accelerating and Running Underway	7-13
Checks After Operation	7-15
Power Trim	7-15
Trim and Tilt	7-18
Trim / Tilt Switch	7-18
Docking	7-18
Mooring	7-20
Anchors and Anchoring	7-21
Lines and Knots	7-23
Trailer and Launching	8-1
Legal Considerations	8-1
Trailer Classification	8-1
Trailer Type	8-1
Trailer Gross Vehicle Weight Rating	8-2
Towing Vehicle	8-2
Vehicle Towing Hitch	8-2
Hitch Ball and Trailer Coupler	8-3
Safety Chains	8-4
Trailer Brakes	8-5
5-Pin Wiring Connector	8-5
Trailer Guidelines	8-6



Engine-Transom Support Bracket	8-6
Backing Up	8-9
Launching	8-9
Loading Guidelines	8-11
Reporting Safety Defects	8-12
Safety Labels and Layouts	9-1
Engine Family Safety Labels	9-2
Individual Safety Labels	9-3
Sportsman Typical Helm Layout	9-6
Sportsman Typical Deck Layout	9-8
Bay Typical Helm Layout	9-10
Bay Typical Deck Layout	9-12
Angler and Guide V Typical Helm Layout	9-14
Angler and Guide V Typical Deck Layout	9-16
Gator Tough™ Deluxe Jon Typical Helm Layout	9-18
Gator Tough™ Deluxe Jon Typical Deck Layout	9-20
Controls, Systems and Options	10-1
Controls and Indicators	10-1
Neutral Start Safety Switch	10-1
Single-Lever Controls - Single or Twin Engine	10-1
Control Operation Guidelines	10-2
Gauges/Instruments	10-3
Switches	10-4
Boat Systems	10-5
Steering System	10-5
Electrical System	10-6
Battery Charging System (If Equipped)	10-9
Bilge System	10-9
Fuel System	10-10
Livewell Systems	10-11
Features and Optional Equipment	10-13
Locking Swivel Fishing Seats	10-14
Locking Swivel Fishing Seats with Friction Control	10-14
Swivel/Slider Seats	10-15
Bow and Stern Light	10-15
Transom Saver	10-16



TABLE OF CONTENTS

Electric Trolling Motor	10-16
Pole Anchor	10-16
12 VDC Accessory Port	10-16
USB Charging Port.	10-17
AM/FM Stereo	10-17
Battery Charger	10-17
Walk-Through Windshield	10-17
Boarding Ladder.	10-17
Turboswing Tow Bar.	10-18
Canopy Top (Option)	10-18
Fuel Filter	10-19
Safety Systems	10-20
Engine Emergency Stop Switch and Lanyard	10-20
General Care and Maintenance	11-1
Repairs and Modifications.	11-1
Safety Equipment	11-2
Life Jackets.	11-2
Boating Equipment	11-4
Corrosion Protection	11-4
Galvanic Corrosion.	11-4
Saltwater Corrosion	11-5
Sacrificial Anodes.	11-6
Hardware, Fasteners and Fittings	11-7
Electrical System	11-8
Direct Battery Charging	11-11
Onboard Charger	11-11
Bilge System	11-11
Bilge Pump	11-11
Engine	11-11
Fuel System	11-12
Steering System.	11-12
General Cleaning and Maintenance.	11-12
Marine Growth	11-13
Cleaning	11-13
Hull	11-13
Vinyl Upholstery	11-14
Vinyl Care and Cleaning Guide.	11-15



Canvas Covers and Bimini Tops	11-16
Non-Skid Flooring	11-17
Carpet	11-18
Windshield	11-18
Mooring and Trailing Covers	11-18
Window Channels	11-20
Teak	11-20
Trailer	11-20
Stainless Steel and Chrome Hardware	11-21
Aluminum Hardware	11-21
Winterization and Storage	12-1
Lifting	12-1
Winterization and Storage Preparation	12-2
Storing on a Cradle or Blocks	12-3
Storing on a Trailer	12-4
Storing During the Summer	12-4
Recommissioning After Storage	12-5
Troubleshooting	13-1
Glossary of Nautical Terms	14-1
Index	I-1



TABLE OF CONTENTS

This Page Intentionally Left Blank

Section 1

INTRODUCTION

Thank you for choosing a G3 boat. This *Owner's/Operator's Manual* contains information you will need for proper operation, maintenance and care. A thorough understanding of these simple instructions will help you to obtain maximum enjoyment from your new boat. If you have any questions about the operation or maintenance of your boat, please consult a G3 dealer.

Because G3 has a policy of continuing product improvement, this product may not be exactly as described in this *Owner's/Operator's Manual*. Specifications are subject to change without notice. This manual should be considered a permanent part of this boat and should remain with it even if the boat is subsequently sold.

This document contains many of Yamaha's valuable trademarks. It may also contain trademarks belonging to other companies. Any references to other companies or their products are for identification purposes only and are not intended to be an endorsement.

ABOUT THIS MANUAL

This manual has been written as a general guide to safe operating practices, boating regulations and maintenance techniques for recreational boating. If this is your first time owning or operating a boat, it is recommended that you contact the boat dealer or local boating agency to find out how to enroll in a boater safety course prior to operating the boat.

This manual is not intended to be used as a replacement for specific information and procedures covered in manuals provided by the manufacturer of the engine, drive, accessories and other major equipment.

Because we are constantly working toward product improvement, this manual is intended to be a general guide only. The illustrations used in this manual may not match the equipment on the boat; they are intended only as general reference views.

This information is supplied with the understanding that the boat will be operated with good seamanship and attention to safe loading, safe operating conditions and safe speed. The manner in which the boat is loaded and operated is the responsibility of the operator.



ABOUT YOUR NEW BOAT

BOAT TERMINOLOGY

It is important that you understand, learn and use appropriate and common nautical terminology while boating to ensure operator safety and the safety of others.

See the *Glossary of Nautical Terms* section of this manual for additional boating terminology.

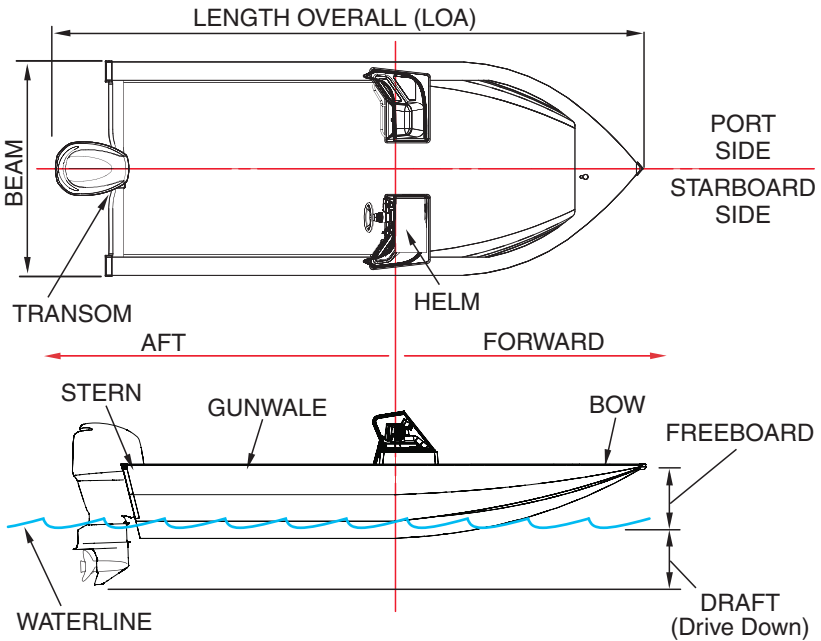

G3_040



HULL IDENTIFICATION, CAPACITY AND SAFETY PLATES

Hull Identification Number

The hull identification number (HIN) is usually located near the upper starboard corner of the transom on the outside of the boat. In some instances, the HIN may be located in an alternate location as determined by the manufacturer (e.g., a pontoon HIN may be located on the aft crossmember approximately 1 foot [0.3 meters] from the starboard hull attachment). The HIN must be clearly visible and may not be removed, altered or tampered with in any way as regulated by federal law.

In case of collision, theft or damage, report these numbers to the local authorities, the insurance agent and the dealer.

Safeguard information about the boat by recording the HIN and model of the boat, and model and serial numbers of the engine and accessories on the Boat Information Form in this manual.

U.S. Coast Guard Safety Standards Compliance Plate

All power boats less than 20 feet (6 meters) must have a manufacturer's compliance plate clearly indicating that the boat is in compliance with the U.S. Coast Guard (USCG) safety standards and the effective date of the compliance. The compliance plate may be combined onto one plate showing both the capacity plate and compliance information by the manufacturer.

As a division of the U.S. Department of Homeland Security, the USCG is the ultimate authority on U.S. waters. The USCG has the right to board any boat for any reason at any time. Failure to obey an order from the USCG can result in a fine, confiscation, imprisonment and even being fired upon in certain areas or conditions.

Certification Standards

The boat was built to meet federal USCG requirements and *may* be certified to more stringent American Boat & Yacht Council (ABYC) standards for the fuel, electrical, ventilation, flotation, horn, identification, capacity, placards and labels, powering, start-in-gear protection, navigation lights, backfire flame control and in most cases, fire extinguishers.

The boat owner is responsible for other USCG-required safety items, which can vary depending on the size of the boat as follows:

- Fire Extinguishers
- Life Jackets
- Visual Distress Signals
- Audible Signaling Device. Boats greater than 65 feet (20 meters) in length must have a bell.



The boat manufacturer or dealer may provide some required safety items. Your boat *may not* be certified to ABYC standards; check the capacity plate for more information.

The person/load capacity is determined by the USCG. The capacity plate is usually located within clear visibility of the boat operator or helm area. The capacity plate indicates limits for loading the boat, which are enforceable by law. Never exceed the “U.S. Coast Guard Maximum Capacities” indicated on the capacity plate.

Boats in the National Marine Manufacturers Association (NMMA) Certification program up to 26 feet (7.9 meters), or a pontoon boat of any length, are certified to ABYC standards, have the USCG maximum rated load capacity on the certification plate and may contain EPA and/or CARB emission information. Do not exceed maximum person or weight capacities. Add the weight of all persons on board; the total weight must not exceed the maximum weight capacity, so it is possible that fewer people than the maximum number can safely ride in the boat.

U.S. COAST GUARD	
MAXIMUM CAPACITIES	
4	PERSONS OR 625 LBS
1300	LBS. PERSONS, MOTOR, GEAR
150	HP. MOTOR
THIS BOAT COMPLIES WITH U.S. COAST GUARD SAFETY STANDARDS IN EFFECT ON THE DATE OF CERTIFICATION	
MEETS U.S. EPA EVAP STANDARDS USING CERTIFIED COMPONENTS	
MODEL: SPORTSMAN1910 G-3 BOATS LEBANON, MO	

0010_G3

DESIGN CATEGORY

Bass boats are designed for use in calm conditions in sheltered waters; Category D. Wave heights over 1 foot (0.3 m) can make bass boating uncomfortable. Waves over 2 feet (0.6 m) can be dangerous and should only be navigated at slow speed.

If you use your bass boat in the Great Lakes or ocean, you should confine your cruising primarily to bays and inlets and constantly monitor the weather for changes. A bass boat is not made to be an oceangoing craft and as such can only be used if the water conditions are similar to an inland lake and only close to shore.

DISCLAIMER

This Owner’s Manual is provided for information and educational purposes only and is not intended to offer or provide legal advice or create a contractual relationship. Please be aware that as a boat owner, you have responsibilities regarding the safety, maintenance, fitness and operation of the boat which cannot be delegated to anyone else. The extent of such responsibilities is ultimately determined by Federal law and regulations, the general maritime law of the United States, the laws and regulations of the states and territories of the United States, or the laws and regulations of the country where you operate the boat.



REFERENCES AND CONTACT INFORMATION

Use the following list of publications and organizations for reference and contact information concerning safe boating, navigational rules and other boating topics.

Publications

- Bottomley, Tom. *Boatman's Handbook*. Hearst Marine Book. Morrow
- Brotherton, Miner. *Twelve Volt Bible*. Seven Seas
- Calder, Nigel. *Boatowner's Mechanical and Electrical Manual*. McGraw-Hill Education
- Chapman, Charles F. and Maloney, E.S. *Chapman's Piloting, Seamanship and Small Boat Handling*. Hearst Marine Book. Morrow
- Hinz, Earl. *The Complete Book of Anchoring and Mooring*. Cornell Maritime Press
- National Fire Protection Association. *NFPA 302 Fire Protection Standard for Pleasure and Commercial Motor Craft*. National Fire Protection Association
- United States Coast Guard. *Navigational Rules for U.S. Waterways*. Visit <https://www.navcen.uscg.gov/> to view or download this publication.
- United States Coast Guard Auxiliary. *Boating Skills and Seamanship Thirteenth Edition*. United States Coast Guard
- Whiting, John and Bottomley, Tom. *Chapman's Log and Owner's Manual*. Hearst Marine Book

Organizations

American Boat & Yacht Council

Boat building standards.
<http://abycinc.org>

American Red Cross

A resource for first aid training, emergency supplies and preparedness.
<http://www.redcross.org> or consult the local telephone directory

Boat Owners Association of The United States

Organization of recreational boaters offering marine services, education and protecting boater's rights.
<http://www.boatus.com/>

BoatU.S. Foundation for Boating Safety Hotline

Training and education outreach directly to boaters.
<http://www.boatus.org/>
Phone: 800-245-2628

***National Association of State Boating Law Administrators***

Boat safety training and education resources.

<http://www.nasbla.org>

National Marine Manufacturers Association

Boat, marine engine and accessory manufacturer trade association.

<http://www.nmma.org>

National Oceanic and Atmospheric Administration's National Weather Service

Nautical charting, weather, fishery, ocean and climate resources.

<http://www.noaa.gov>

National Safe Boating Council, Inc.

<http://www.safeboatingcouncil.org>

Sea Tow Services International, Inc.

Organization of recreational boaters providing towing and more.

<http://www.seatow.com>

Toll free: 800-473-2869

U.S. Coast Guard

<http://www.uscgboating.org> (To contact the U.S. Coast Guard for an emergency while on the water, always use the onboard VHF-FM radio channel 16. Use cell phones only as a secondary means of communication. Call 9-1-1 to reach rescue personnel.)

U.S. Coast Guard Auxiliary

Information on boating safety classes and boat safety checks.

<http://nws.cgaux.org>; Phone: 877-875-6296

U.S. Coast Guard Navigation Center (NAVCEN)

USCG navigation information.

<https://www.navcen.uscg.gov>

U.S. Coast Guard Office of Boating Safety

USCG resources for recreational boaters.

<http://www.uscgboating.org>

U.S. Coast Guard's America's Waterway Watch Program

A program for recreational boaters to assist the U.S. Department of Homeland Security in reporting suspicious activity on U.S. waterways; Phone: 877-249-2824



U.S. Government Publishing Office

<http://www.gpo.gov>

(For information and documentation on FCC rules and regulations and Skippers Course information, and other government, marine and nautical related documents)

U.S. Power Squadrons

Boating courses and knowledge resources.

<http://www.usps.org>; Phone: 888-367-8777

Water Sports Industry Association

Water sports education, safety and risk management.

<http://www.wsia.net>



BOAT INFORMATION FORM

BOAT			
Boat Manufacturer:			
Hull Colors:			
Weight:			
Length:			
Draft:			
Beam:			
Vertical Clearance:			
Dealer:			
Dealer Representative:			
Dealer Phone:			
Boat Model:			
Hull ID Number (HIN):			
Registration Number:			
Registration State:			
Purchase Date:			
Delivery Date:			
Warranty Expiration Date:			
Manufacturer Representative:			
Manufacturer Phone:			
ENGINE, DRIVE AND PROPELLER			
Engine Make:			
Engine Model Number	Port:	Engine Serial Number	Port:
	Stbd:		Stbd:
	Center:		Center:
Ignition Key Number:			
Drive Make:			
Drive Model Number	Port:	Drive Serial Number	Port:
	Stbd:		Stbd:
	Center:		Center:



ENGINE, DRIVE AND PROPELLER	
Propellers	Make:
	Type:
	Size:
	Material:
	Part Number:
SYSTEMS AND ACCESSORIES	
Fuel Filter Part Number:	
Battery Make:	
Battery Size:	
ACCESSORIES	
Manufacturer:	
Model:	
Serial Number:	
Manufacturer:	
Model:	
Serial Number:	
Manufacturer:	
Model:	
Serial Number:	
Manufacturer:	
Model:	
Serial Number:	
TRAILER	
Trailer	Make:
	Model Number:
	Serial Number:
	GVWR:
	Tire Size:



SECTION

1

INTRODUCTION

This Page Intentionally Left Blank

Section 2

SAFETY

The popularity of boating and other water sports has undergone an explosion of growth in the past few years, making safety an important issue for everyone who shares in the use of the waterways.



WARNING

Operation Hazard: Read and understand this Basic Boating and Safety Manual, the Engine Operator's Manual and all manufacturer-supplied information regarding the operation of equipment. The boat operator must understand all safety information responsibilities, regulations, controls and operating instructions before attempting to operate the boat. Improper operation could result in death or serious injury.

The safety content and precautions listed in this manual and on the boat are not all-inclusive. If a procedure, method, tool or part is not specifically recommended, the operator must feel confident that it is safe for them and others, and that the boat will not be damaged or become unsafe as a result of the operator's decision. REMEMBER – ALWAYS ASSESS EACH SITUATION AND USE SOUND JUDGMENT!

The boat operator is responsible for their own safety, as well as that of passengers and other boaters.

SAFETY INFORMATION

The safe use and operation of this boat depends upon the operator following proper operating techniques as well as common sense, good judgment and expertise. Every operator should know the following requirements before operating the boat.

- Before operating the boat, read this *G3 Owner's/Operator's Manual*, the *Owner's/Operator's Manual* for the outboard motor, the literature for all other equipment supplied with the boat or trailer, and all warning and caution labels on the boat, motor and trailer. These materials should give you an understanding of the boat and its operation.
- Never allow anyone to operate this boat until they too have read the *Owner's/Operator's Manual* and all warning and caution labels.



LIMITATIONS ON WHO MAY OPERATE THE BOAT

- G3 recommends that an operator be at least 16 years of age before operating the boat.
- Adults must supervise use by minors.
- Know the operator age and training requirements for your state. G3 recommends operators take a boating safety course, and some states require it. Contact the United States Coast Guard (USCG), the National Association of State Boating Law Administrators (NASBLA) or your local Power Squadron for details about your area.
- This G3 boat has maximum capacities for the number of passengers and weight on board. Never exceed these maximum load limits. Weight distribution affects performance. Keep weight in the boat low and evenly distributed from side to side and front to back. Remove any unnecessary cargo and store it on shore.

GOOD BOATING PRACTICES

Boating-related accidents are generally caused by the operator's failure to follow basic safety rules or written precautions. Most accidents can be avoided if the operator is completely familiar with the boat, its operation and the navigational rules of the road and can recognize potentially hazardous situations.

In addition to everyday safety, failure to observe safety recommendations may result in severe personal injury or death to the operator or to others. Use caution and sound judgment when operating the boat. Do not take unnecessary chances! Failure to adhere to these warnings could result in death or severe injury to the operator and/or others.

Read this entire manual and be aware of other specific safety guidelines not listed in this manual. Seek additional safety information from the USCG and state and local authorities. In addition to specific safety statements noted in this manual, a general list of safety guidelines and recommendations is listed below:

- The boat must comply with USCG safety equipment regulations.
- Before each outing, check all safety equipment such as fire extinguishers, life jackets, flares, distress flags, flashlights and engine emergency stop switch. Make sure they are operable, in good condition, readily visible and easily accessed.
- Onboard equipment must always conform to the governing federal, state and local regulations.
- Never allow any type of spark or open flame on board. It may result in fire or explosion.



- Take the keys/FOBs when leaving the boat to keep untrained and unauthorized persons from operating the boat.
- Know how to react correctly to adverse weather conditions, have good navigation skills and follow navigational rules as defined by USCG, state and local regulations.
- Check local weather reports before casting off. Do not leave the dock area when strong winds and electrical storms are in the area or predicted to be in the area.
- Seek shelter from open water if lightning is an imminent threat.
- Tell someone of the travel plans before departing.
- Know the weight capacity of the boat. Never overload the boat.
- Never operate the boat while under the influence of drugs or alcohol.
- Look before turning the boat. The boater is obligated to maintain a course and speed unless it is safe to alter course and speed. Look before turning.
- Operators must read and understand all operating manuals supplied with the boat before operation.
- Whenever planning an outing, make sure that at least one passenger is familiar with the operation and safety aspects of the boat in case of emergency.
- Passengers should never sit in front of the operator; always avoid obstructing the operator's view.
- Show all passengers the location of emergency equipment and explain how to use it.
- Never allow passengers to drag their feet or hands in the water, or sit on the bow, bow pulpit, railing, deck or gunwale while the engine is running.
- Never use or hold on to the boarding platform while the engine is running.
- Never stand or allow passengers to stand in the boat or sit on the transom, seat backs, engine cover or sides of the boat while the engine is running. The operator or others may be thrown from the boat.
- Children and nonswimmers must wear a life jacket at all times.
- Never leave children in the boat without adult supervision.
- Improper operation of the boat is extremely dangerous.
- Securely attach the engine emergency stop switch lanyard around your leg or to a part of your clothing such as a belt loop, when operating the boat. Instruct others on how to start the boat if you as an operator are thrown overboard. Consider having an extra lanyard readily available on board since the system cannot be overridden without the lanyard that is on the person who is now overboard.
- Operate slowly in congested areas such as marinas and mooring areas.
- The bow may be slippery. Do not go forward while the engine is running.
- Slow down when crossing waves or wake in order to minimize the impact on passengers and the boat.



- Never replace the boat's marine parts with automotive parts (if applicable).
- Never remove or modify any components of the fuel system. Always have qualified personnel perform fuel system maintenance. Tampering with fuel components may cause a hazardous condition.
- Avoid contact with engine exhaust gases—engine exhaust contains carbon monoxide.
- Never operate the engine in a confined space.
- Never go under the boat cover with the engine running or shortly after the engine has been running.
- Allow adequate ventilation with fresh air before entering any enclosed areas.
- Watch for other boats, swimmers and obstructions in the water. Stay away from other boats and personal watercraft (PWCs).
- Never swim near a boat when the engine is running. Even if the boat is in the NEUTRAL position, the propeller may still be turning and carbon monoxide may be present.
- Never dive from the boat without being absolutely sure of the depth of the water; severe injury or death may occur from striking the bottom or submerged objects.
- Never wrap ski lines or mooring lines around any body part. You could become entangled in the line if you fall overboard while the boat is moving.
- Keep track of ski lines and dock lines so they do not become entangled in the propeller.
- Have an experienced operator at the helm and always have at least three people present for safe towing—one to drive, one to observe, and one to ski or ride.



BOAT SETUP

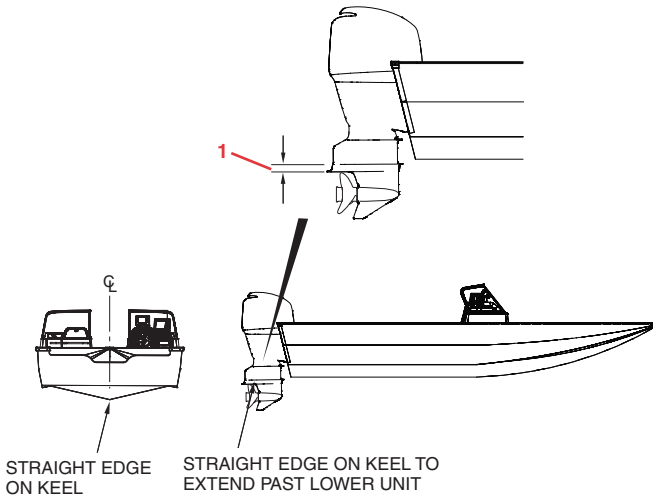

G3_039

The G3 boat is shipped from G3 with almost all of the necessities required to operate it. Not all boats will be equipped the same as others, as you have the option to accessorize and customize the boat.

A G3 facility or a G3 dealer has already installed the outboard motor. The installation height (1) may have to be adjusted to optimize and maximize its performance. (The installation height is the distance from the bottom of the cavitation plate to the top of the straight edge.) Never adjust the installation height, as this must be done by qualified people who can establish the correct installation height. The installed height is based on an average, since G3 cannot predetermine the boat's loads or uses. Never add accessories or other items in an attempt to increase performance, as this can end up inhibiting performance and safety. If you believe you are experiencing poor performance, contact your G3 dealer.

Do not use a jack plate to adjust installation height on the G3 boat unless the boat is specifically designed for one, and then only use the G3-recommended jack plate. G3 considers other jack plate installations to be misuse and will not cover them by warranty.

**WARNING**

Control Hazard: Do not attempt to alter the G3 boat to increase performance. Modifications could make the boat unsafe to use, increasing the risk of severe injury or death.

SAFETY AND TRAINING

There is a vast amount of recreational boating regulatory, safety and training information online, and much of it is free. This information covers laws, aids to navigation, rules of the road, hands-on boating safety courses, boat safety checks and much more for both novices and experienced boaters. Go to the following sites for more information:

- United States Coast Guard
www.uscgboating.org
- United States Power Squadron
www.usps.org
- BoatU.S. Foundation
www.boatus.org

STRONG POINTS

Your boat is equipped with designated strong points that are designed to support the weight of the boat and engine for lifting the boat from the water. Additionally, only strong points should be used for towing another boat or towing an inflatable tube. Never use cleats and/or ski tow pylons for lifting or towing.

SAFETY LABELS

The boat is affixed with various hazard and safety labels at the time of manufacture. These labels appear in specific locations on the boat and on equipment where safety is of particular concern. All operators of the boat must read and understand all hazard and safety labels and advise all passengers on the safety concerns and proper practices. Hazard and safety labels must remain legible. If the operator suspects a label is missing or damaged they should contact the dealer for replacement.



SAFETY STATEMENTS

There is no substitute for sound judgment and careful practices. Improper practices or carelessness can cause burns, cuts, mutilation, asphyxiation, other bodily injury or death. This information contains general safety precautions and guidelines that must be followed to reduce risk to personal safety. Special safety precautions are listed in specific procedures. Read and understand all of the safety precautions before operation or performing repairs or maintenance.



NOTE — This safety alert symbol appears with most safety statements. It means attention, become alert, your safety is involved! Please read and abide by the message that follows the safety alert symbol.

**DANGER**

Indicates a hazardous situation that, if not avoided, will result in death or serious injury.

**WARNING**

Indicates a hazardous situation that, if not avoided, could result in death or serious injury.

**CAUTION**

Indicates a hazardous situation that, if not avoided, could result in minor or moderate injury.

NOTICE

Indicates a situation that can cause damage to the boat and accessories and/or the environment, or cause the equipment to operate improperly.



SAFETY PRECAUTIONS



DANGER

The safety messages that follow have **DANGER** level hazards. These safety messages describe hazardous situations that, if not avoided, will result in death or serious injury.



Training Hazard: Do not permit anyone to launch, operate or retrieve the boat without proper training.

- Read and understand this Basic Boating and Safety Manual and all manufacturer-supplied information before operating or servicing the boat to ensure that you follow safe operating practices and maintenance procedures.
- Safety signs and labels are additional reminders for safe operating and maintenance techniques.
- See the boat dealer for additional training.



Exhaust Hazard: Carbon monoxide (CO) is a colorless and odorless gas produced by all engines, fuel-burning appliances and any material that contains carbon and is burned. Direct or prolonged exposure to carbon monoxide will cause brain damage or death.



Electrocution Hazard: Docks and other boats nearby can carry sources of electricity. Faulty wiring or the use of damaged electrical cords and other devices not approved as “shore or marine rated” can cause the surrounding water source to become energized from electricity leakage. Never enter the water or swim in a marina.



WARNING

The safety messages that follow have **WARNING** level hazards. These safety messages describe hazardous situations that, if not avoided, could result in death or serious injury.



Fire/Explosion Hazard: Gasoline is extremely flammable and highly explosive under certain conditions.

- Compartments for fuel, flammable liquids or gases must be properly ventilated to prevent explosive vapors from accumulating. Most vapors are heavier than air. If not in a vapor-tight locker vented overboard, vapors will accumulate in the bilge, posing a fire and explosion hazard.
- Inspect fuel system for leaks at least once a year.



Fire/Explosion Hazard: Hydrogen gases produced by a lead-acid battery while it is charging, or the engine is running, can cause an explosion and/or a fire.

- Always wear personal protective equipment when working on or around batteries.
- Keep the area around the battery well-ventilated.
- Do not smoke or bring an open flame or any other form of ignition near a battery.
- Do not check for a dead battery by placing a metal object between the battery posts. Sparks could cause an explosion.
- Do not place your head directly above a battery when making or breaking electrical connections.
- Always charge the battery outside of the boat.
- Do not use a battery booster to start the engine.



Sever Hazard: Make sure nobody is near the propeller before starting the engine(s).

- Do not allow swimmers to approach or use the ladder when the engine is running.
- The operator should walk to the stern and check the water for people near the propeller, as people in the water may not always be noticeable from the helm.
- Turn off the engine(s) before allowing people to board or exit the boat. The propeller may continue rotating even when the engine is idling or in NEUTRAL.
- Show passengers the location of the propeller and teach them to keep their distance from it at all times, even when the propeller is not in motion.
- Show passengers the propeller warning labels around the boat and discuss propeller dangers.
- Be particularly alert when boating in high-traffic areas and never operate in swimming zones.
- Exercise caution when operating near boats that are towing skiers and tubers.
- Never allow passengers to sit in areas where they could fall overboard, including the bow, gunwale, transom, seat backs, or other locations.



- **Carefully watch children aboard the boat at all times.**
- **Instruct passengers on the rules for using the swim platform, boarding ladders and seats. If possible, instruct them to stay seated at all times while the engine is running.**



Man Overboard Hazard: Always remain seated in the boat manufacturer's designated seating arrangement, use handholds and never block the view of the boat operator while underway. The boat's bow, gunwale, transom platform and seat backs are not intended for use while underway.

- **If someone falls overboard, slowly turn the boat around while keeping an eye on the victim. Ask a passenger to help monitor the victim. Always STOP THE ENGINE before rescuing a victim from the water.**
- **Never put the engine in REVERSE to retrieve a person from the water. Slowly circle back to the person again if necessary.**



Entanglement Hazard: Rotating or moving parts can entangle or sever body parts.

- **Do not wear jewelry, unbuttoned cuffs, ties or loose-fitting clothing.**
- **Tie long hair back when working near moving or rotating parts such as the flywheel or propeller shaft.**
- **Keep hands, feet and tools away from all moving parts.**
- **Keep all guards in place when the engine is operating.**
- **Use caution when working with ski or mooring lines so they do not become entangled with the propeller.**



Exposure Hazard: Wear personal protective equipment, including appropriate clothing, gloves, work shoes, eye and hearing protection, as required by the current task.



Control Hazard: Do not operate the boat while you are under the influence of alcohol or drugs or if feeling ill. Federal laws prohibit operating a boat under the influence of alcohol or drugs. These laws are vigorously enforced.

**CAUTION**

The safety messages that follow have CAUTION level hazards. These safety messages describe hazardous situations that, if not avoided, could result in minor or moderate injury.



Slip/Trip Hazard: Keep the boat free of water, oil, mud and other foreign matter. Do not wax deck and swim platform surfaces. Remove anything that creates slippery areas around the boat.

NOTICE

The safety messages that follow have NOTICE level hazards. These messages are used to indicate a situation that can cause damage to the boat and accessories and/or the environment, or cause the equipment to operate improperly.

- *Unapproved modifications to the boat or systems may impair the boat's safety and performance characteristics and shorten the boat's life. Any alterations to the boat may void its warranty. Always consult the boat manufacturer before making modifications or adding equipment.*
- *ALWAYS be environmentally responsible. Follow the guidelines of the EPA or other governmental agencies for the proper disposal of hazardous materials such as engine oil and fuel. Collect all trash and dispose properly on shore. Keep our waters clean! Consult the local authorities or reclamation facility.*



Carbon Monoxide (CO)



DANGER

Exhaust Hazard: CO gas is colorless, odorless and extremely dangerous. All engines and fuel-burning appliances produce CO as exhaust. Direct and prolonged exposure to CO will cause brain damage or death. Always avoid exposing your passengers or yourself to CO.



Even with the best boat design and construction, plus the utmost care in inspection, operation and maintenance, hazardous levels of CO may still be present in accommodation areas under certain conditions. To reduce CO accumulation, always provide adequate ventilation in the boat interior by opening the deck hatches, windows or canvas.

Do not confuse carbon monoxide poisoning with seasickness, intoxication or heat stress. If someone complains of irritated eyes, headache, nausea, weakness, dizziness or drowsiness, or you suspect carbon monoxide poisoning, immediately move the person to fresh air, investigate the cause and take corrective action. Seek medical attention if necessary.

Always use a CO detector in confined areas where there is a possibility of CO buildup, such as enclosed canvas, sleeping quarters, galleys and head compartments. Regularly check the condition of the CO detector for proper operation.

Make sure that all passengers know what the CO detector alarm sounds like. If the alarm sounds, shut down engines and generator, move passengers to fresh air for at least 10 minutes, reset the alarm and investigate the cause. Ventilate the space thoroughly before restarting engines and generator.

Test the carbon monoxide detector operation before each trip, at least once a week and after the boat has been in storage. Also have the CO detectors professionally tested at regular intervals. Most CO detectors are required to be replaced every 5 years – see the OEM manual.



Potential Causes of CO Poisoning While Underway

Blockage of boat exhaust by obstruction

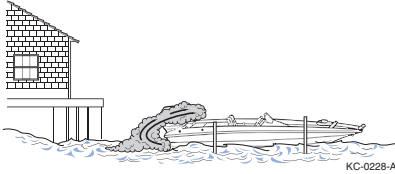

Exhaust from other vessels in confined areas



Operating at a high bow angle



Operating at slow speed or while idling

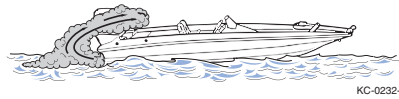

Exhaust traveling along obstruction



Always ensure adequate fresh air ventilation through the boat when underway.

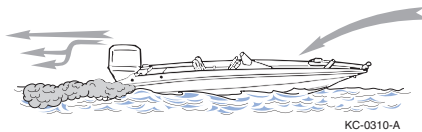

KC-0297-B



REQUIRED BOATING SAFETY EQUIPMENT AND REGULATIONS

U.S. Coast Guard Minimum Onboard Safety Equipment Required
(Your boat may be equipped with one or more requirements by the manufacturer, but it is the boat owner's responsibility to have these items on board.)

	LESS THAN 16 FT (4.9 M)	CLASS 1: 16 TO LESS THAN 26 FT (4.9 TO LESS THAN 7.9 M)	CLASS 2: 26 TO LESS THAN 40 FT (7.9 TO LESS THAN 12.2 M)	CLASS 3: 40 TO 65 FT (12.2 TO 19.8 M)
LIFE JACKETS AND PERSONAL FLOTATION DEVICES (PFDs)	One U.S. Coast Guard-approved wearable life jacket for each person on board	One U.S. Coast Guard-approved wearable life jacket for each person on board and one throwable PFD device		
VISUAL DISTRESS SIGNALING DEVICES	One (1) electric distress light OR three (3) day and night combination red flares	One orange distress flag or one electric distress light OR three floating or handheld orange smoke signals and one electric distress light OR three day and night combination red flares, handheld, parachute or meteor type		
AUDIBLE SIGNALING DEVICES	A boat less than 39.4 ft (12 m) must have on board an efficient sound-producing device. (Example: hand or mouth whistle OR a compressed or powered air horn)		A boat 39.4 ft (12 m) but less than 65.6 ft (20 m) in length operating in inland waterways must carry a power whistle OR powered air horn AND a bell	
NAVIGATION LIGHTS	Regulations require that navigational lights be clearly lit and properly displayed at all times between sunset and sunrise and always when operating in reduced visibility while boating			



	LESS THAN 16 FT (4.9 M)	CLASS 1: 16 TO LESS THAN 26 FT (4.9 TO LESS THAN 7.9 M)	CLASS 2: 26 TO LESS THAN 40 FT (7.9 TO LESS THAN 12.2 M)	CLASS 3: 40 TO 65 FT (12.2 TO 19.8 M)
FIRE EXTINGUISHERS	<p>One 5-B type (U.S. Coast Guard-approved)</p> <p>If the boat meets any one or more of the following conditions, the boat must carry one 5-B type USCG-approved extinguisher on board:</p> <ul style="list-style-type: none"> • Inboard/sterndrive engine powered • Has closed compartments where portable fuel tanks can be stored • Has double bottom construction that has areas where air or gases can be open or trapped • Has an enclosed living space • Has compartments where flammable, combustible or explosive materials are stored • Has permanent fuel tanks installed • Boat is 26 ft (7.9 m) or more in length 	<p>One 20-B OR two 5-B type (USCG-approved) (A fixed extinguishing system is equal to one 5-B.)</p>	<p>One 20-B AND one 5-B OR three 5-B type (USCG-approved) (A fixed extinguishing system is equal to one 5-B.)</p>	
EMERGENCY ENGINE STOP SWITCH	<p>Powered boats less than 26' (7.9 m) operating in Federal waters must be equipped with an engine stop switch and operator interface.</p>			



FIRE EXTINGUISHER

USCG-approved fire extinguishers are required on all Class I, II and III boats. Mount all handheld fire extinguishers in readily accessible areas away from the engine compartment and other combustible devices. All passengers must know the location and operating procedure of each extinguisher. Follow the manufacturer's instructions for proper use and operation of the fire extinguisher.

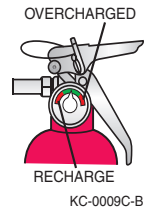

All fire extinguishers used on marine boats must be classified to extinguish type B fires (gasoline, oil or grease). The size and number of required fire extinguishers depend on the size of the boat. The two type B fire extinguishers commonly used are 5-B and 20-B. Type B fire extinguishers are classified by the different extinguishing compound amounts used in each.

Check the fire extinguisher condition and pressure gauge regularly, if not before every trip, to ensure that the fire extinguisher is in good operating condition and is fully charged. If the fire extinguisher is damaged or not properly pressurized, replace it. Disposable (non-rechargeable) fire extinguishers with a date of manufacture stamped on the bottle older than 12 years must be removed from service and no longer count towards the minimum carriage requirements.

See the *U.S. Coast Guard Minimum Onboard Personal Safety Equipment Required* section of this manual for specific onboard requirements.

ENGINE EMERGENCY STOP SWITCH AND LANYARD

The engine emergency stop switch is an extremely important safety device. Use the engine emergency stop switch when operating the boat's engine. This safety device prevents the boat from becoming a runaway if the operator is accidentally thrown from the seat or away from the helm. The USCG recommends and many states require the use of the emergency stop switch by law. Check with local and state authorities about usage requirements to avoid potential fines.

Starting April 1, 2021, individuals operating most types of powered boats less than 26' (7.9 m) in Federal waters are required to use an engine emergency stop switch and lanyard while the boat is on plane or above displacement speed.

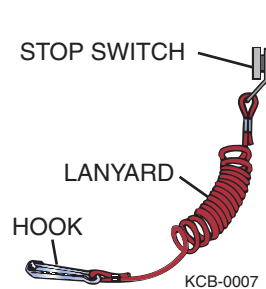

- Tiller-steered models may have a switch mounted on the tiller handle with a wrist lanyard.
- Side-mount controls may have a switch on the control box with a "clip-on" lanyard.



- Larger boats may have a helm-mounted switch with a “clip-on” lanyard.
- Some boats may have a wireless switch with a FOB attached to the operator. Consider having an extra lanyard readily available on board since the system cannot be overridden without the lanyard that is on the person who is now overboard.

**WARNING**

Control Hazard: Never remove or modify the engine emergency stop switch and/or lanyard.

- ***Always check the switch for proper operation. With the engine running in neutral, pull the lanyard. If the engine does not stop, have the switch repaired before continuing to operate the boat. Never operate the boat if the engine emergency stop switch does not work.***
- ***Avoid accidentally pulling the cord lanyard during normal operation. Loss of engine power means loss of most steering control. Also, without engine power, the boat could slow rapidly. This could cause people and objects in the boat to be thrown forward.***

LIFE JACKETS

Boaters enjoy the feel of sun and spray, so it's tempting to boat without wearing a life jacket, especially on nice days. However, the failure to wear life jackets is by far the number one cause of boating fatalities.

Modern life jackets are available in a wide variety of shapes, colors, sizes and technologies. Many are thin and flexible. Some are built right into fishing vests or hunter coats. Others are inflatable and as compact as a scarf or fanny pack until they hit water and automatically fill with air. Ensure all passengers on board understand where the life jackets are located and how to put them on and use them.

There's no excuse for not wearing a life jacket on the water. Boat dealers or marine stores are the best sources for guidance when selecting this most important piece of safety equipment.

Starting in 2020, the U.S. Coast Guard working in cooperation with Transport Canada started transitioning to new life jacket labeling based on a performance classification system acceptable in both countries. If you have older approved life jackets, devices are approved in one country or the other, but not both. U.S.-approved devices are still acceptable in the U.S., and Canadian-approved devices are still acceptable in Canada when used in accordance with the approval label.

Always check and read the manufacturer's information booklet and label provided with all new life jackets. They will provide valuable information, including size, type, intended use, approval, inspection, and care information. For more information, go to <http://wearitlifejacket.com/>.



Things to Know about Life Jackets:

- Life jackets are now classified as wearable or throwable on the label.
- We recommend that all boaters and passengers wear a life jacket at all times while boating.
- Certain life jackets are designed to keep the head above water and help you remain in a position that permits proper breathing.
- To meet USCG requirements, a boat must have an approved life jacket for each person aboard. Boats 16 feet (4.9 meters) and over must have at least one throwable device as well.
- All states have regulations regarding children wearing life jackets. Special life jackets for children are available and based on the weight of the child.
- Adult-sized life jackets will not work for children. To work correctly, a life jacket must be worn, fit snugly and not allow the child's chin or ears to slip through.
- Test life jackets for wear and buoyancy at least once each year. Discard waterlogged, faded, leaky or damaged jackets.
- Properly stow life jackets but make them easily accessible.
- A life jacket, especially a snug-fitting flotation coat or deck-suit style jacket, can help people survive in cold water.
- Various types of life jackets are also available for pets.
- A life jacket can save a boater's life, but only if the boater wears it. Set the example and wear it whenever near the water.

Life Jackets Must Be:

- New jackets must be USCG or Transport Canada approved
- In good and serviceable condition
- Appropriately sized for the intended user
- Appropriate for the water activity
- Snug-fitting
- The best life jacket is the one you will wear

Accessibility

- Throwable devices must be immediately available for use in emergency situations.
- Wearable life jackets must be readily accessible.
- Boaters must be able to locate and put them on in a reasonable amount of time in an emergency.
- They should not be stowed in plastic bags, in locked or closed compartments, or have other gear stowed on top of them.



Child Life Jacket Federal Requirements

No person may operate a recreational boat underway with any child under 13 years old aboard unless each such child is either: (1) Wearing an appropriate PFD approved by the Coast Guard; or (2) Below decks or in an enclosed cabin.

Some states require that children wear life jackets at all times; check with the state boating safety authorities.

Since children grow quickly, many boat launches now feature free use of children's life jackets in several different weight categories.



SCAN ME VIDEO

KCB-0130

Life Jacket Requirements for Certain Boating Activities Under State Laws

The USCG recommends, and many states require, wearing USCG-approved life jackets:

- For waterskiing and other towed/surf activities, use a life jacket designed for waterskiing. **It is illegal in many states to participate in towed water sports without a USCG-approved life jacket. Be aware that some specialized water sports vests are NOT USCG-approved and should be worn in addition to a USCG-approved life jacket.**
- While operating personal watercraft (PWC) use a life jacket marked for PWC or waterskiing use.

Check with the state boating safety authorities. Other rules may apply if boating in an area under the jurisdiction of the Army Corps of Engineers or a federal, state or local park authority. Special local rules are usually posted at the boat launch.

The new life jacket labels make it easier for the boat owner to choose the appropriate sizes and types of jackets for the boat. Labels may be in English, French Canadian or both languages depending on where they are marketed, but all will use icons for key performance indicators.

Size

Chest size is used on ADULT devices to further define the fit not used on all others. Weight is used to define the basic size groups of:

- INFANT <30 LBS
- CHILD 30-50 LBS
- YOUTH 50-90 LBS
- ADULT >90 LBS



Performance Level

The performance level indicates the amount of floatation provided. The higher the number, the more floatation at the increase in bulk.

- Lower numbers are more comfortable to wear and are a good choice for near-shore, calm water boating.
- Mid numbers offer more stability for people who do not swim and for novice swimmers and are a better choice for coastal boating.
- Higher numbers have the greatest floatation and are the best choice for remote areas where rescue times may be long, for non-swimmers, and for offshore use.

Turnability

Typically, jackets with low performance levels will not turn an unconscious person face-up. Jackets with mid performance levels may not turn an unconscious person face-up. Jackets with high performance levels will turn an unconscious person face-up.

Warnings

Some life jackets are not approved for waterskiing, tubing, wakeboarding, white-water paddling, or use on a personal watercraft.

Find More Information

Additional information on the life jacket in the owner's manual and web sources.





Manufacturer and Approval Information

Manufacturer's information for possible future recalls. USCG approval number and certification agency to assure the jacket meets the law and is safe to use.

Use, Care and Storage Information

A summary of the use, care and storage information contained in the owner's manual.



<p>ADULT UNIVERSAL User Weight: > 41kg (>90 lbs) Chest Size: 76-132 cm (30-52 in.)</p>	SIZE
<p>70 </p>	PERFORMANCE LEVEL
<p></p>	TURNABILITY
<p></p> <ul style="list-style-type: none"> • Approved only when worn • Drowning hazard if not worn. • Must be fastened and properly adjusted to float the wearer. 	WARNINGS ON USE
<p>Choose and wear the device which fits you and your activity, visit www.XXXXX.com* Read and keep the owner's manual and tags for info on wear and care.</p>	FIND MORE INFORMATION
<p>Company Name Company Address Company website if available Indication of Country of Origin USCG Approved 160.064/XXXXX ANSI/UL 1123- TYPE III Model: Lot No.</p> <p>Lab Certification Mark Certifying Lab Identification and Address</p>	MANUFACTURER & APPROVAL INFORMATION
<p>Use: Fasten all closures and adjust for a snug fit. Inspection: Inspect your life vest before each outing. Do not use if your life vest shows signs of weathering, damage, or rot. Care and Storage: Dry thoroughly after each outing. Store in a dry cool place out of direct sunlight.</p> <p></p>	USE, CARE AND STORAGE INFORMATION

KCB-0129



Inflatable Life Jackets

U.S. Coast Guard-approved inflatable life jackets are authorized for use by persons 16 years of age and older (check the label).

- They require regular maintenance. Also, pay attention to the condition of the inflator.
- They must have a full cylinder and all status indicators on the inflator must be green. If all status indicators are not green, the device is not serviceable and does not satisfy the legal requirements for the wearable life jacket carriage requirement.
- They must be worn at all times.

VISUAL DISTRESS SIGNALING (VDS) DEVICES

There are a variety of VDS devices for day, night, or day and night use. Pyrotechnic devices can be dangerous if used improperly; read the instructions before using. Pyrotechnic devices expire and must be replaced every few years, as stamped on the unit. Be sure to properly dispose of old pyrotechnics.

Distress lights and strobes are equipped with batteries that must be replaced every few years, as stamped on the unit.

Advancements in technology have led to a number of electronic VDS devices (eVDSD). These devices are battery-powered and contain one or more LED lights and possibly other features. While eVDSDs are not “USCG Approved,” they are accepted as “equivalent” if compliant with RTCM Standard 13200.0 for nighttime use. Several can be equipped with a VDS flag for day/night use and/or a whistle for audible signaling. Talk to your boat dealer about the best device for your use.

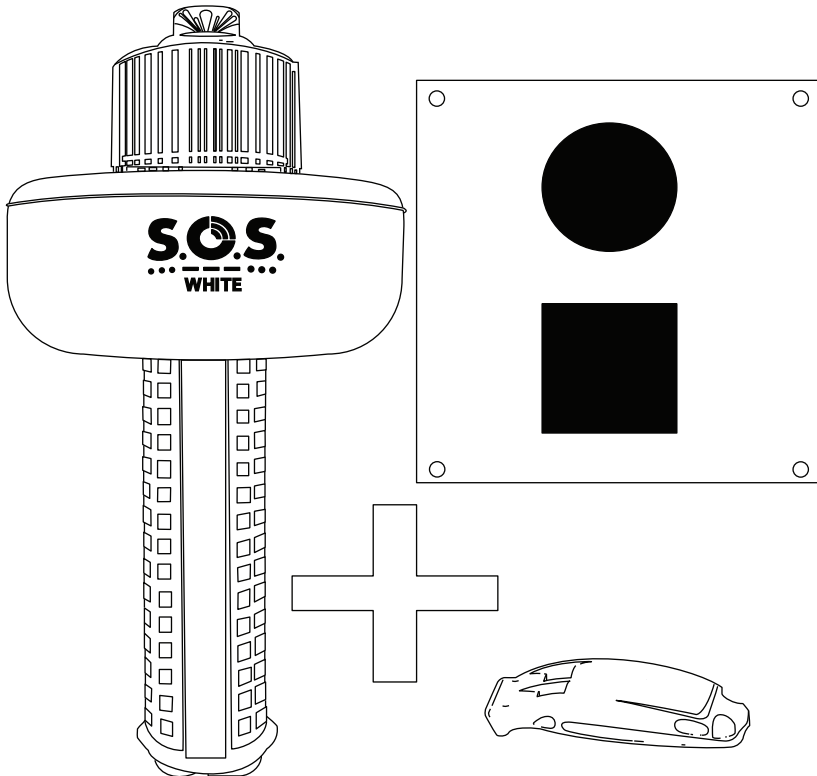

KCB-0131

Boats less than 16 feet (4.9 meters) must have USCG-approved visual distress signals (VDS) on board when operating between sunrise and sunset in coastal waters, including ocean bays, gulfs and sounds, as well as the Great Lakes, seas, bays and river mouths that are 2 or more miles wide and only to the point proceeding inland where the water narrows to less than 2 miles. Visit the U.S. Coast Guard website for additional information on specific VDS requirements for the boat.

Ensure all passengers on board understand how to operate all VDS. Keep VDS in a readily accessible area and within immediate reach at all times when boating.



VISUAL DISTRESS SIGNALS

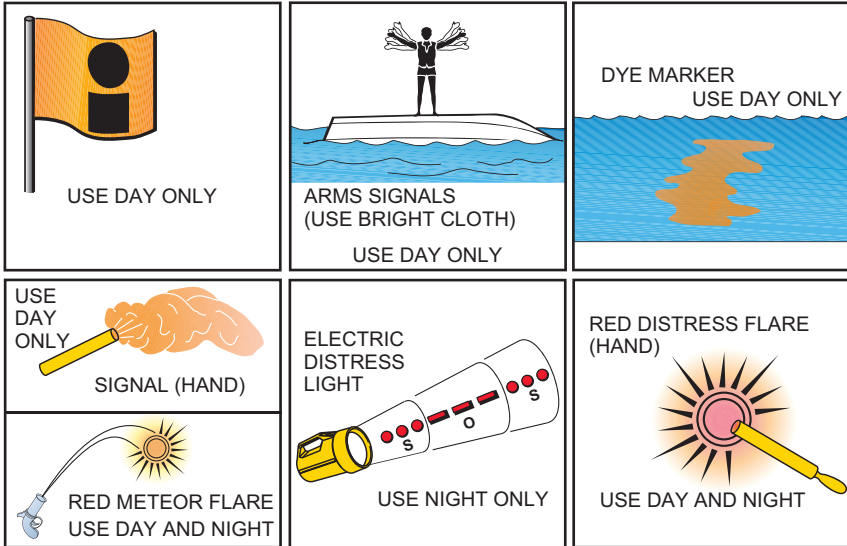

KC-0008C-B

Regulations prohibit using pyrotechnic VDS or any VDS in non-emergency situations.

VDS must be:

- USCG-approved
- In proper operating condition
- Safely stowed and readily available
- Within the clearly marked expiration date stamp on the device (where applicable)

Types of VDS vary by emergency situation. VDS are classified as either pyrotechnic or non-pyrotechnic.

NOTE — Some pyrotechnics may be restricted on certain bodies of water. Check with local authorities, or visit the National Association of State Boating Law Administrators (NASBLA) website: <http://www.nasbla.org> or the U.S. Coast Guard website: <http://www.uscg.mil> for additional information.

See the *U.S. Coast Guard Minimum Onboard Personal Safety Equipment Required* section of this manual for specific onboard requirements.



AUDIBLE SIGNALING DEVICES

Audible (sound) signals are required to be on board all boats to alert other boats of your presence or intentions. A boat less than 39.4 feet (12 meters) must always have an efficient sound-producing device on board (Example: hand or mouth whistle, or a compressed or powered air horn).

A boat at least 39.4 feet (12 meters) but less than 65.6 feet (20 meters) operating in inland waterways must always have a power whistle or powered air horn and a bell on board.

All devices must be acceptable for use in marine environments, audible for 1/2 nautical mile and maintain a continuous four- to six-second sound duration. The diameter of the bell's mouth must be a minimum of 7.9 inches (20.0 centimeters).

Ensure all passengers understand how to operate all audible distress signaling devices on board. Keep these devices in a readily accessible area and within immediate reach at all times when boating.

See the *U.S. Coast Guard Minimum Onboard Personal Safety Equipment Required* section of this manual for specific onboard requirements and see the *Navigational Lights and Night Operation* section of this manual for usage information.

NAVIGATIONAL LIGHTS

Navigational lights are intended to alert other boats to your presence and course and their use is essential to boating safety and the prevention of collisions. Knowledge of navigation lights is necessary for the boat operator. Regulations require that navigational lights be clearly lit and properly displayed at all times between sunset and sunrise, and always when operating in reduced visibility. The placement, shape and visibility requirements of navigational lights vary depending on boat size, type, activity and the body of water. Do not allow passengers, gear or stowed items to block navigation lights. Check with local authorities, or visit the NASBLA or U.S. Coast Guard website for additional information.

If the boat is equipped with bow and/or stern pole style plug-in lights, be sure to orient the pole properly in the receptacle and lock in place. The white light is for the stern and the combination red/green light is for the bow, center. If using separate bow lights, the red light is for the front left (port), and the green light is for the front right (starboard). After inserting, check for proper operation of the lights.

For additional information, see the *Navigational Lights and Night Operation* section of this manual.



Show Lighting

The navigational lighting required by the USCG from sunset to sunrise and in inclement weather is extremely important to boat navigation. The lighting rules are not only designed to indicate direction and right-of-way, but are also designed to prevent night blindness and confusion with navigational aid, emergency and shore-based lights.

The arrival of inexpensive LED lights and red/green/blue (RGB) controllers suitable for “show” use has become extremely popular with boaters. Installing supplemental lighting for “show” can be very dangerous, confusing and distracting to other boaters, and may be illegal. The operator is responsible for complying with local laws and must be familiar with local marine lighting regulations that are constantly evolving before use. Keep these points in mind for show lighting:

- Do Not install lighting outside of the boat above the waterline.
- Do Not install lighting inside the boat above the gunnels where the light source can be seen directly from outside the boat.
- Use caution when changing RGB light color, as some light colors may not be compliant with certain local ordinances; blue lighting is typically reserved for law enforcement use only.
- Be sure to switch off show lighting and lighted accessories such as speakers (not navigation lights) when underway. Most states allow the use of underwater lighting while underway.
- Use only factory-installed, low-intensity courtesy lighting or “mood” lighting when underway.

NOTICE

Never use onboard accessory equipment containing LED lighting when underway.



RECOMMENDED SAFETY EQUIPMENT

Carry and know how to use the following equipment in addition to the required equipment on board at all times as an extra safety precaution:

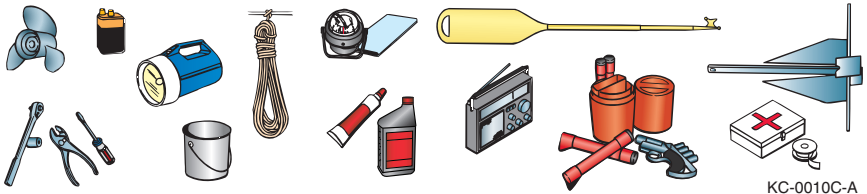

KC-0010C-A

Anchor and line with minimum 75 feet (23 meters) of line	GPS Global Positioning Device
Auxiliary starting battery	Insect repellent
Binoculars	Local charts and compass
Boat hook	Mirror, whistle and strobe light
Cellular phone with waterproof case and lanyard	Mooring lines
Compass	Navigational and interior light bulbs
Dock fenders	Oar/paddles
Dry bag	Propeller, nut and washer
Duct and electrical tape	Radio
Electrical wire	Sharp folding pocket knife
Emergency food and water	Solar USB charger and cable
Emergency Position Indicating Radio Beacon (EPIRB)	Spark plugs
Engine lubricant	Sunglasses and sun block
Extra drain plug	Thermal clothing
Extra transom plug	Throwable life ring
First aid kit and manual	Tool kit including propeller replacement tools
Flashlight and radio batteries	Tow line
Foul weather gear/clothing	VHF-FM/AM with weather band radio
Fuses	Waterproof flashlight



VERY HIGH FREQUENCY (VHF) RADIO

The VHF radio is used to communicate with others on and off the water. VHF channel 16 (156.8 MHz) is designated as the international distress, safety and calling channel and is used to summon rescue services such as the USCG and to make initial contact with ports, marinas, bridges, locks and other boaters in the area. Use a VHF radio. The best way to clearly understand and deal with crossing, overtaking and meeting situations in open water is to communicate with the other boat on the radio.

The responder may then ask the caller for other information to help the caller. It is important to remain calm, speak slowly and be succinct. Short and concise communications are best no matter what the situation is.

Since VHF radios have limited distance line-of-sight (to the horizon) capabilities, it is important for all boaters receiving the distress call to attempt to render assistance until the rescue authorities arrive. The very nature of open water escalates the importance of any distress call. Boaters should always monitor (listening watch) channel 16 but never use it for casual communications. Assist others in distress if possible or monitor the situation until help has arrived.

In other communications, call the other party on channel 16 using your call sign. Bridges and locks will instruct boaters on what to do. Harbors, marinas and other boaters in the area will inform boaters to switch to a particular channel. Most VHF radios transmit in “simplex,” where communication can only take place in one direction at a time. For this reason, standard etiquette is to never interrupt a transmission and to wait 15-30 seconds before making a transmission. There are many channel options available for both commercial and non-commercial use.

NOTICE

The USCG is the lead agency for maritime search and rescue (SAR) in U.S. waters, but that mission is compromised every time the service receives a hoax distress call. Making a false distress call is a violation of federal law (14 U.S. Code § 88) and may result in up to six years in prison, a \$250,000 criminal fine, a \$5,000 civil fine, and reimbursing the U.S. Coast Guard for the cost of performing the search.

Using a VHF radio in foreign waters with a U.S.-registered boat may require a federal Ship Station License by law or treaty. Traveling to a foreign port (for example, Canada, Bahamas, British Virgin Islands and Mexico) requires a Ship Station License as well as a restricted radiotelephone operator permit (RR). Go to www.fcc.gov/wireless/bureau-divisions/mobility-division/ship-radio-stations for more information.

Read the VHF manufacturer’s information on the special features and use of the radio.



PERSONAL LOCATION BEACON (PLB)

While an EPIRB is registered to the vessel, a PLB is registered to the user. Similar to an EPIRB, PLBs must be registered in the National Oceanic and Atmospheric Administration (NOAA) Search And Rescue Satellite Aided Tracking (SARSAT) database with personal information that is required to be updated every two years and reported if the unit is sold. Handheld waterproof marine PLBs also have long-lasting batteries stamped with an expiration date. Since the PLB identifies the user, it can also be used on land when hiking or for other remote activities.

SITUATIONAL AWARENESS

A good captain knows that it is important to continuously observe the surroundings and traffic when operating. Good captains also use their eyes to track things around the boat and their ears to hear engine and mechanical issues. Technology should only be used to supplement the conditions and events happening around you and is not meant to replace situational awareness. While available technology and automation help captains see the big picture, the captain is responsible for knowing what is going on around the boat. If possible, post a lookout or lookouts when underway.

Do not get immersed in the boat's technology or blindly follow GPS routes without keeping watch or consulting depth charts. Study the manuals for each piece of equipment and monitor the information for the task at hand, be it depth, traffic, infrared camera, engine data, course or weather.

DRIVING DEFENSIVELY

Sharing boats is becoming more popular in the boating culture. Boating has seen an influx of new, inexperienced and untrained boaters due to peer-to-peer boat-sharing apps and boat clubs. It is increasingly probable that someone on the water "tried" boating because it looked fun. Many of the boat owners sharing their boats do little more than cover safety equipment, starting, stopping and docking instructions. With shares lasting half a day or less, there is little time for much training, let alone covering the rules of the road and navigation.

Boat-sharing is in a legal gray area and is not clearly defined in maritime law. Enforcement of existing rules is nearly impossible and almost always after-the-fact. Operators should assume that the other boat operator is untrained and should drive defensively. Boaters choosing to share their boat should discuss the issue with their insurance agent first and consider a mandatory captain requirement. Use only reputable sharing services and frequently check for new or updated USCG and state requirements.



SMALL BOATS AND SWIMMERS

Canoes, kayaks, paddleboards and swimming inflatables have become impulse purchases for many, as they appear fun to use and prices have fallen. Most of these operators are new to the sport and have no training on rules of the road or navigation. This is further complicated by the low, thin profile that makes these small boats difficult to see, especially in the sun, glare and rough water. Operators should keep a close lookout for these boats, swimmers and other boats. Assume that the person is untrained and give them plenty of space.

KNOWING THE BOAT

Be thoroughly familiar with onboard systems and other equipment, especially the critical systems and equipment such as throttle and shift controls, steering, backup steering, running lights, fuel filters, sea strainers, and all emergency safety equipment. Should an emergency arise, the captain will need to act safely and efficiently.

SPECIAL NEEDS PASSENGERS

Keep these special precautions in mind when enjoying a day on the water with passengers who have special needs.

Toddlers

- Never leave children in the boat without adult supervision.
- Must weigh at least 18 pounds (8.2 kilograms), since that is the smallest children's life jacket approved by the USCG. Life jacket must be worn whenever near the water.
- Any device the child is placed in must have flotation.
- Child-proof the boat just like a home. Be sure all gates and compartments are closed and latched.
- Keep a close watch on the child's reaction to speed and conditions and react accordingly.
- Use a higher than normal SPF waterproof sunscreen and re-apply more often than usual.
- Find a safe area to put the child down without risk of going overboard. Allow the child to get accustomed to the surroundings before launching/leaving.
- Keep trips short, but let them have some fun if possible.



Pregnant Women

- Go boating during the day and in calm seas.
- Avoid sharp turns and slow down for large wakes.
- Drink more water than usual to stay hydrated.
- It is a good idea to stay seated in the accommodation deck area while underway.
- Stay close to the home port in the third trimester.

People with Handicaps and Elderly People

Depending on the disability, there are many marine-specialized options available to make boats safer and friendlier. Researching on the internet for your specific needs is the best way to start.

Pets

- Not all pets can swim; consider a life jacket.
- If playing fetch in the water, get a pet-friendly boarding ramp to make re-boarding easier.
- Provide a shaded area and plenty of fresh drinking water.
- Consider foot protection for hot sand and boat surfaces.
- Allow the pet to get accustomed to the surroundings before launching/leaving. Keep the first outing short to allow the pet to get used to the boating environment.

CRUISING LIMITATIONS

- Scan constantly for people, objects and other watercraft. Be alert for conditions that limit your visibility or block your vision of others.
- Operate defensively at safe speeds and keep a safe distance from people, objects and other watercraft.
- Do not follow directly behind other watercraft.
- Do not go near others to spray or splash them with water.
- Avoid sharp turns or other maneuvers that make it hard for others to avoid you or understand where you are going.
- Avoid areas with submerged objects or shallow water.
- Operate within your limits and avoid aggressive maneuvers to reduce the risk of loss of control, ejection and collision.
- This is a sophisticated boat—not a toy. Sharp turns or jumping waves or wakes can increase the risk of back/spinal injury (paralysis), facial injuries, broken legs, ankles and other bones. Do not jump waves or wakes.



- Do not operate the boat in rough water, bad weather or when visibility is poor; this may lead to an accident causing injury or death. Be alert to the possibility of bad weather. Take note of weather forecasts and the prevailing weather conditions before setting out in the boat.
- Leave a “float plan” with a responsible person on shore. Tell where you plan to go and when you plan to arrive, and provide a description of your boat. Advise this person if your plans change and also when you arrive to prevent false alarms. Refer to *Float Plan* in this manual for additional information.

HAZARD INFORMATION

- Never start the engine or let it run for any length of time in an enclosed area. Exhaust fumes contain carbon monoxide, a colorless, odorless gas that may cause death within a short time. Always operate the boat in an open area.
- Do not use the reverse function to slow down or stop the boat, as it could cause you to lose control, be ejected or impact the steering wheel or other parts of the boat. This could increase the risk of serious injury. It could also damage the shift mechanism.
- Reverse can be used to slow down or stop during slow speed maneuvering, such as when docking. Once the engine is idling, shift to REVERSE and gradually increase engine speed. Make sure that there are no obstacles or people behind you before shifting into REVERSE.
- Stop the engine and remove the clip from the engine stop switch before removing any debris or weeds that may have collected around the propeller.

WATER SPORTS

 **WARNING** *Control Hazard: It is unlawful to participate in water sports while under the influence of alcohol or other drugs.*

Some boats are not designed or recommended to be used for water sports. For recreational boats, water sports include any activity performed in the water such as waterskiing, kneeboarding, wakeboarding, wakesurfing, hydrofoiling, swimming, diving, snorkeling or gliding using a device that may be pulled by a boat. Boats equipped with a ski pylon, tower or hard top tow point, or a transom-mounted ski tow eye can be used for most water sports in accordance with the capacity limits listed on the label.



Inflatables, also known as tubes, have some unique safety considerations and require the use of both stern eye strong points in combination with a proper tube harness and tow rope; see *Inflatables/Tube Tips* in this section for more information. Parasails and kites require specialized equipment and training and should never be used with a recreational boat.

Check with local and state authorities or water sports clubs and affiliations for additional information.

PLATFORM DRAGGING

These dangerous and even fatal activities can lead to any or all of the following, as well as other dangers not listed here:

- Carbon monoxide poisoning
- Severe injury from a rotating propeller
- Drowning or entrapment under the water

NOTICE

It is UNLAWFUL to be on or holding on to the boarding platform, swim deck, swim step, swim ladder or any portion of the exterior of the transom at any time while the boat is running or underway in any direction and at any speed.



WARNING

Personal Injury Hazard: Body, teak or platform dragging is extremely dangerous and can be fatal. Never hold on to the transom of a boat while in the water when the boat is running or underway.

- ***Do not use the boarding platform or ladder for any purpose other than boarding the boat or entering the water.***
- ***Do not use the boarding platform or ladder while the engine is running.***
- ***Do not swim under the boarding platform when the engine is running.***



WATER SPORTS GUIDELINES

Boat Operator, Occupants and Participants

The following water sports guidelines only cover the general conditions that frequently arise. The participants must respond to the constantly changing weather and the conditions of the sea by using reasonable and safe judgment in light of the circumstances.

- Always ensure that all water sports participants and occupants of the boat, especially the operator, are fully aware at all times of the participants' condition and location in the water, as well as the surrounding environment.
- Make safety the primary concern of all involved during the activity. Only allow safe and capable participants to engage in the activity.
- The boat operator and water sports participants must always know their limitations in the activity and never exceed them.
- Never perform water sports in or near:
 - Congested areas
 - Restricted areas
 - Navigation or other waterway markers
 - Other boats
 - Other water sports participants
 - Obstructions in the water
 - Shorelines
 - Shallow water
 - Hazardous weather conditions
 - Hazardous waterways, rapid moving water, dams, spillways, etc.
 - Areas or times of restricted visibility
 - Hours between sunset and sunrise
 - Locations too far from shore that could hinder immediate rescue or emergency help if needed
- Always engage in water sports activities in safe waterways only.
- Always attach the water sports tow rope to approved attachment points on the boat.
- Never jump from a boat that is moving at any speed, and do not enter or exit the water when the engine is running.
- Never use different length ropes simultaneously for water sports activities.
- Always make sure that participants know and use approved skiing hand signals and common skiing courtesy.



- Before starting, always agree to speed and communication hand signals between the boat operator, spotter/observer and participants.
- Before starting, always inspect the water sports equipment and tow eye, tow point and tow line for safe operating condition, or damage that may lead to failure.

Know Water Sports Hand Signals

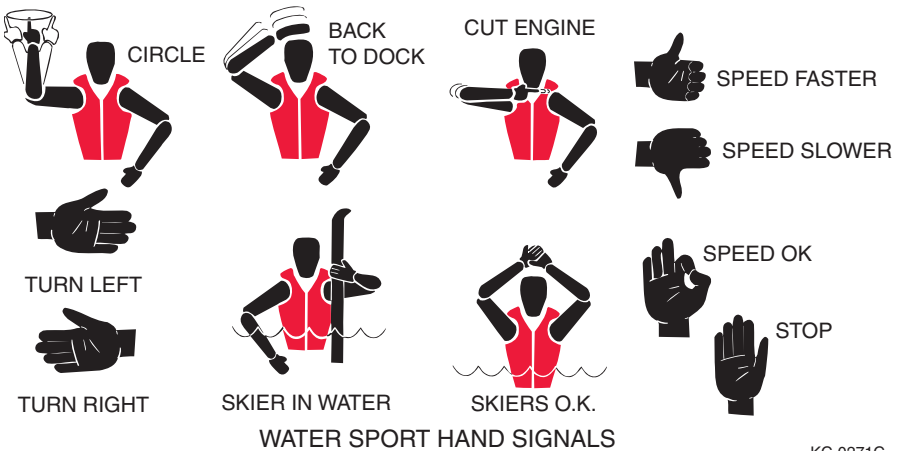

KC-0271C

Boat Operator Specific Guidelines

The following guidelines are for the boat operator while a participant is in the water.

- Always have a “spotter” (designated observer) other than the boat operator on board to ensure the safety of the participants in the water and provide communication to and from the boat operator and the participants.
- Always turn the engine off from a safe distance when approaching participants in the water and allow them to reach the boat. Never run the engine near a person in the water.
- Never operate the boat in reverse to retrieve anyone in the water.
- Always return immediately to a fallen water sports participant. Always approach the participant on the operator’s side while keeping the participant in view from a direction opposite the wind or seas.
- Never drive directly at a person in the water or directly behind another boat.



- Always maintain a safe distance from people and objects in and on the water.
- Always look in the direction you plan to turn before turning the boat to pick up a fallen skier.
- Never retrieve any object from the water while the engine is running.
- Always keep the skier in view when the skier is entering or exiting the boat.
- Always watch the skier as the line begins to tighten (in case the rope wraps around ski or skier).
- Always look ahead before starting.
- Always start from a safe place with good forward and peripheral visibility.
- Always check direction of steering before starting, ensuring that the boat steers straight.
- Always be aware of what is occurring in front of the boat, and of a participant's condition.
- Always display a "skier down" flag whenever a skier is in the water and not skiing.
- Always follow the approved towing pattern for the waterway in which you are operating.

Additional Guidelines for Participants in the Water

The following guidelines are for the water sports participant.

- Never participate in water sports if you cannot swim.
- Always wear a bright-colored USCG-approved activity life jacket at all times. Wear suitable protective clothing or gear and/or a wet suit to prevent impact injuries, abrasions and hypothermia.
- Never approach or enter the boat if the engine is running.
- Always avoid the boat's propeller. Even when the propeller is not rotating, its sharp edges can cause serious injury.
- Never put any part of your body through the handle of the ski line or wrap the line around any part of your body.
- Never enter the water from a boat that is running or moving at any speed.
- Always indicate that you are clear of the boat prior to the operator starting the boat or putting the boat into gear and tightening the rope.



Inflatables / Tube Tips

Today's market offers various types, shapes and sizes of towed inflatables (known as “tubes” or “inflatables”). A person can ride “in” or “on” (depending on the style) these inflatables while out on the water. Regardless of the type, they all produce tremendous stress on the tow point and rope, far greater than devices like water skis, kneeboards or wakeboards. When using tubes, keep the following points in mind:

- Follow the general water sports safety guidelines in this section for operating the engine, using life jackets, using a spotter, guarding against rope entanglement, reviewing equipment condition before use, understanding rider skill levels, and abiding by regulations for distances to other boats, docks and shorelines.
- Do Not exceed a towing speed greater than 8 mph (11 km/h) for small children, 15 mph (24 km/h) for children up to 18 years old, or 20 mph (32 km/h) for adults.
- Do Not attempt to intentionally cause a tube rider to fall and use extreme caution with multiple riders to prevent slamming riders together.
- Do Not use tow ropes shorter than 50 ft (15 m), or longer than 65 ft (20 m). Be sure the tow rope and tube is rated for the combined weight of all riders and uses the proper attachment points. A braided tow rope offers a degree of stretch to minimize shock to the rider.
- Do Not use ski tow pylons, hard top, tower or ski tow eye points for tubes. Use both port and starboard stern eye strong points with a tube tow harness to attach the tube tow rope. Add a floating ball to the tow rope to keep the rope on top of the water and improve performance. If you do a lot of tubing, invest in a transom-mounted bracket made specifically for towing tubes (see your dealer).
- Check the tube air pressure often and keep at the manufacturer's recommended level as listed on the device. Pressure levels can change rapidly from sun and shade; too low and it creates additional drag, too high and it may cause tube failure.
- Tow only one tube at a time.
- Read and understand the user's manual for the tube; instruct children on the Do's and Don'ts.



CAUTION

Personal Injury/Equipment Damage Hazard: Ski tow pylons/tower/hard top/ski eye tow points are not designed for use with tubes. The added stress of the tube may cause a dangerous recoil or damage the tow point. Damage to the pylons/tower/hard top/ski eye tow points is not covered by the boat or equipment manufacturer's warranty. If towing tubes/inflatables, use both stern eye strong points with a tube tow harness to attach the tube tow rope. Consult the boat manufacturer for stern eye tow limits.

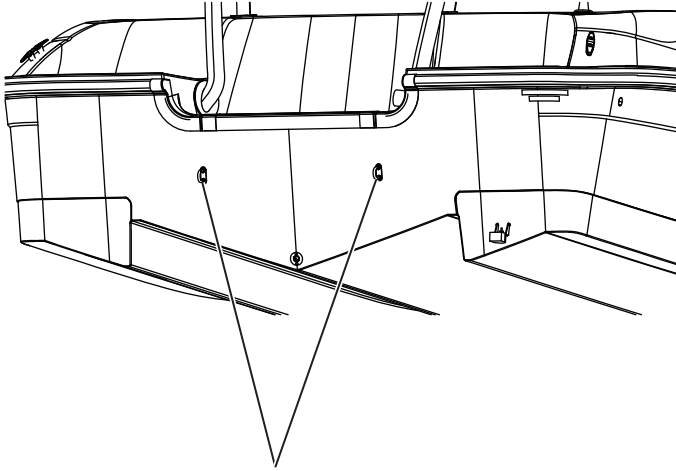

STERN EYES

KCB-0108

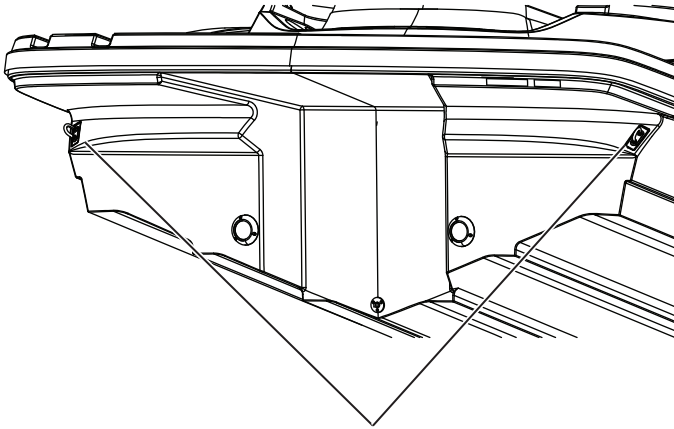

STERN EYES

KCB-0109



Assisted Re-boarding



WARNING

Personal Injury Hazard: Always turn the engine off whenever anyone is in the water near the boat.

Use caution when re-boarding boats without ladders. Assisted re-boarding requires the boater to first determine how he/she will attempt to re-board the boat before entering the water. Take into account your physical capabilities and the layout of the boat, including mounted accessories. We recommend that all occupants test re-boarding of the boat in a safe, controlled environment before use. Unless a boater is fully confident they can re-board the boat unassisted, a permanently attached re-boarding ladder is necessary.

Boats with low freeboard can be re-boarded without the use of ladders or assistance, but it is important to remain calm. Locate the lowest portion of the boat (lowest freeboard) where re-boarding would be easiest to do with a solid handhold to assist with pulling oneself into the boat. Small boats can be unstable, so it is important to be careful not to flip the boat during re-boarding. To re-board:

1. Make sure the engine's propeller and mounted accessories are a safe distance away from you being accidentally hit.
2. Locate a solid handhold and pull until your torso or leg transfers onto the boat.
3. Roll the rest of your body onto the deck of the boat.

Re-boarding ladders are available for purchase from the boat dealer.

Using the Platform / Boarding Ladder



WARNING

Personal Injury Hazard: Always turn the engine off whenever anyone is in the water near the boat.

To board, carefully deploy and use the boarding ladder if available. You may also pull yourself onto the boarding platform to enter the cockpit of the boat. Boats equipped with a boarding platform have a few extra precautions to be aware of:

- NEVER allow anyone on the boarding platform or in the water near the platform while the engine is running.
- NEVER attempt to surf on or off the platform while the engine is running.
- NEVER "platform drag" or touch the boarding platform from the water while the engine is running.
- NEVER exceed the weight capacity of the boarding platform. All boarding platforms have weight limits. If there is no capacity label, ask the dealer.



- Boarding platforms may be wet and slippery. Advise passengers to use caution and any available handholds when using the platform. Never apply wax to the working deck portion of the platform.
- If the boarding platform is equipped with a ladder, be sure the ladder is fully retracted and secured before operating the boat.
- If the boarding platform is removable, be sure it is properly secured before operating the boat.

Designated Occupant Seating

It is important to use the designated occupant positions (DOP) when underway, if applicable. You must also understand that even though the capacity label identifies the number of passengers for your model, the actual number of passengers is determined by weight. Your boat model may have 10 DOP seats and a capacity label that says 8 persons or 1500 pounds. This means that you may have a maximum of 10 people as long as the sum total weight of all the people and gear does not exceed 1500 pounds. Likewise, it may be possible that the 1500-pound limit *could be exceeded with only 7 people or less.*

For more information on capacity, see *Section 1, Hull Identification, Capacity and Safety Plates*. For more information on seating, see *Section 2, Safety*. For more information on the proper distribution of passengers on the boat, see *Section 7, Boat Loading*.

Section 3

BOATING REGULATIONS AND YOUR RESPONSIBILITIES

The U.S. Coast Guard (USCG) is the federal authority on U.S. coastal and inland waterways, but state and local regulations may exist that exceed USCG regulations. The purpose of all these regulations is to assist the boating public and maintain navigational order on waterways.

Many state equipment requirements go beyond USCG requirements. Contact state and local boating authorities for further information. Equipment requirements for coastal and inland waters differ. Check with local authorities or the USCG for further information about coastal water requirements.

Boating regulations are enforced by USCG, state and local authorities. Operators/owners are subject to marine navigation regulations for both federal and state waterways. Operators/owners must comply if enforcement officers signal them to stop the boat or if they ask to board the boat.

Many USCG, state and local resources are available. For additional and current information on regulations, safety and navigation, contact the local USCG unit or local marine authority.

See the *References and Contact Information* section of this manual for a list of resources.

BOAT OWNER / OPERATOR RESPONSIBILITIES

As a boat owner/operator, understand and be aware of USCG federal regulations as well as state and local regulations where operating the boat. Boating regulations include, but are not limited to, boat regulations, boat equipment regulations and navigational regulations.

Operators/owners must have on board at all times all mandatory safety and boat equipment as regulated by the governing authorities. All equipment must be maintained in proper working order.

SAFETY

Boat owners/operators are legally responsible for their safety, the safety of their passengers and the safety of other boaters. In addition, they are responsible for the operation and navigation of the boat under all operating conditions. The boat must be in compliance with USCG safety equipment regulations.



REGISTRATION

The USCG requires that all power boats operated on the navigable waters of the United States be currently registered in the state in which they are principally used. Many states require current registration in that state whenever boating on waters within their state boundary. Always contact state boating authorities (and authorities in neighboring states) for registration information on boats and trailers.

Registration numbers must be current and clearly displayed on the boat according to the defined regulations. Registration certificates must be current and on board at all times.

State and local authorities may require additional registration for boating on certain waterways. Check with state and local authorities for additional registration information.

For more information visit:

- U.S. Coast Guard Office of Boating Safety:
<http://www.uscgboating.org>
- National Association of State Boating Law Administrators:
<http://www.nasbla.org>

INSURANCE

Boat owners are legally responsible for any damage or injury caused when they operate the boat when an accident or collision occurs. They are also legally responsible even when someone else operates the boat and causes damage or injury. Individual states have laws detailing minimum insurance needs. Contact the insurance agent to verify the type of insurance needed BEFORE operating the new boat.

REPORTING ACCIDENTS

The USCG requires the owner/operator of a boat involved in an accident to report the incident to the proper marine law enforcement agency for the state in which the accident occurred. If a person dies or disappears as a result of a recreational boating accident, the boat owner/operator must immediately notify the nearest state boating authority. If a person dies or has injuries requiring more than first aid, the owner/operator must file a formal report within 48 hours of the accident. An owner/operator has 10 days to file a formal report for accidents exceeding \$500 in property damage or complete loss of the boat. Go to <http://uscgboating.org/recreational-boaters/>, Accident Reporting, for information and form download.



BOATING UNDER THE INFLUENCE



KCB-0011

Federal and state laws prohibit the operation of a boat while under the influence of alcohol or drugs, and authorities actively enforce these regulations. If the operator's blood alcohol content is at or above the legal limit, violators are subject to civil and criminal penalties and imprisonment. Operating a boat under the influence can also result in a loss of motor vehicle driving privileges.

Alcohol and drugs slow reaction time and affect judgment. This type of impaired operation may result in death or severe personal injury.

Owners/operators are responsible for their passengers, including alcohol and drug use and onboard behavior.

Regulations and penalties for operators and passengers may vary from state to state. Contact local and state boating authorities for specific information.

OPERATOR'S LICENSE AND EDUCATION

This manual does not provide complete training on all aspects of boating safety, operation or regulations. Boating authorities highly recommend that all boat operators and passengers seek additional training in boating safety and seamanship from a USCG-approved course.

Licensing requirements can vary widely from state to state. Most states require operators under the age of 18 to be licensed; however, some states require all operators to be licensed and have the license on the boat during operation. Some states require boat operators to complete a boating education/safety course to obtain a safety certificate before licensure. Pay special attention if you will be operating on boundary waters shared by two or more states, as the requirements may change once you cross the boundary.

Check with state and local authorities for requirements of an operator's license, certificate or training before you or anyone operates the boat.

See the *References and Contact Information* section of this manual for a list of some of the agencies and organizations that offer water/boating safety courses, first aid/CPR, or other recommended training and/or information.

OPERATION BY MINORS

Minors must always be supervised by an adult whenever operating a boat. Many states have laws regarding the minimum age and licensing requirements of minors. Regulations may vary from state to state. Contact local and state boating authorities for specific information.



EMERGENCY ASSISTANCE

An operator seeing a distress signal or suspecting a boat is in trouble must assume it is a real emergency and render assistance immediately as long as it can be done safely.

In accordance with Federal law, in U.S. waters, the operator must render assistance to any individual found at sea in danger of being lost, so far as the operator can do so without serious danger to the operator's vessel or individuals on board. An operator who fails to render such assistance can be fined not more than \$1,000, imprisoned for not more than 2 years, or both. The 1971 Boating Safety Act grants protection to a "Good Samaritan" boater providing good faith assistance, and absolves the boater from any civil liability arising from such assistance.

Under general maritime law in international waters on the other hand, if the operator undertakes to perform acts to rescue or aid those in distress, the operator is subject to liability for reckless or wanton conduct or, for failure to exercise reasonable care (negligence) if he worsens the position of the victim.

NOTICE

The operator in charge of the boat is obligated to provide assistance to any individual in danger if such assistance can be provided safely. Carefully assess the situation at hand and assist if possible. If the operator does not possess the skills to safely assist another boat in trouble with the highest degree of care, call for help and stay in the area until help arrives.

NEGLIGENT OPERATION

Federal law prohibits the negligent or grossly negligent operation of a boat and/or interference with the safe operation of a boat so as to endanger lives and/or property. Some actions that may constitute grossly negligent operation (criminal offense) are:

- Operating a boat in a designated swimming area
- Excessive speed in the vicinity of other boats or in regulated waters
- Hazardous waterskiing or other water sports practices
- Bow riding, or riding on a seat back, gunwale, boarding platform or transom
- Operating a boat while under the influence of alcohol or drugs (severe penalties may be imposed for boating under the influence [BUI])



Other actions that constitute negligent operation, such as, but not limited to:

- Failure to use handhold
- Overloading or improper loading
- Using a boat in weather or sea conditions beyond the intended design of the boat or beyond the skill or experience of the operator
- Continued operation with operator's visibility blocked or impaired
- Modification to boat causing an unsafe operating condition

RESTRICTED AREAS

Security Zones

Operators must avoid all waterways and areas that are restricted, such as military installations, power plants and petroleum and chemical facilities. Because of the threat of terrorism, the U.S. Coast Guard has implemented and will continue to enforce strict limits on boats near U.S. Navy and U.S. Coast Guard ships and other potential targets.

Naval Vessel Protection Zones

Do not approach within 100 yards of any U.S. Naval vessel. Slow to minimum speed within 500 yards of any U.S. Naval vessel. Operators needing to approach within 100 yards to ensure a safe passage in accordance with the Navigation Rules must contact the U.S. Naval vessel or the U.S. Coast Guard escort vessel on the boat's VHF radio (channel 16) for authorization.

Commercial Shipping Safety Zones

Do not operate the boat near cruise liners or certain waterfront commercial installations such as ferry terminals. Observe and avoid all security zones and commercial port operations.

Bridges and Shipping Channels

Do not stop or anchor beneath bridges or in shipping channels. Operators doing so should expect to be asked to move and/or be boarded by law enforcement officials. Anchoring in these areas is dangerous for the operator and others on the water.



AMERICA'S WATERWAY WATCH

Boat operators can help the U.S. Coast Guard in keeping waterways and coastal installations safe and secure. Boat operators can do this by participating in America's Waterway Watch (AWW). Boaters reporting suspicious activities to AWW should call 877-24WATCH if noticing suspicious activity or behavior on or near the water.

In cases of immediate danger to life or property, call the U.S. Coast Guard on channel 16 VHF-FM or dial 911 for emergencies.

FISHING

Fishing can be very exciting and distracting for the operator when the action gets intense. Operators must always be conscious of the primary responsibility, which is the safe operation of the boat and the safety of passengers and other boats in the area.

Always make sure the helm is properly manned and is never left unattended while trolling. If the boat is equipped with a tower, exercise caution and sound judgment whenever someone is in the tower. Remember, weight in the tower raises the boat's center of gravity and the boat's motion is greatly exaggerated for the person in a tower.

An operator fishing in an area that is crowded with other fishing boats may have difficulty following the rules of the road. This situation can become especially difficult when many boats are trolling. Being courteous and exercising sound judgment is essential. Avoid trying to assert the right-of-way and concentrate on staying clear of other boats. Prevent the boat from becoming entangled in lines and from cutting into lines. Also keep in mind that fishing line wrapped around a propeller shaft can damage seals in the engine lower unit.

There is currently a tremendous drain on our fishing resources. Excessive fishing and hunting, as well as pollution, have strained the fish and game population. Help out by keeping only what you will eat; practice catch-and-release and obey bag limits.

Monofilament Fishing Line

Wildlife can experience harm from becoming entangled in or ingesting monofilament fishing line if it is left in the water or on shore. Line in the water can also endanger swimmers and divers and become tangled in boat propellers, causing damage. It can last for years in water, posing a threat for a long time. Fishing line can remain a problem even if put in the trash, because birds can take it from an open bin and become entangled or it can entangle wildlife at landfills.



Many states and private boating/wildlife organizations sponsor programs to collect used line for recycling into new products. Operators who carry used line or happen upon it while boating can dispose of it in recycling bins located at many marinas, launches, tackle shops and state service centers.

WAKE

Boat owners/operators are responsible for the wake the boat creates. Regulations may vary from state to state. Contact local and state boating authorities for specific information, as owners/operators may be responsible for any damage or injury their wake causes. Always be alert for no-wake zones and be courteous of others while boating. Excessive and unexpected wakes can cause dangerous and even life-threatening situations.

NOISE

Boat owners/operators are responsible for the noise the boat creates. Many state and local boating authorities enforce noise limits that may restrict engine noise, radio volume or even loud talking. Regulations may vary from state to state. Contact local and state boating authorities for specific information.

SPEED

Boat owners/operators are responsible for maintaining the boat under control at a safe speed. Many state and local boating authorities enforce speed limits. Regulations may vary from state to state. Contact local and state boating authorities for specific information.

SHALLOW WATER BOAT STABILITY

Boat designs for flats, bays, poles and skiffs are very similar. Because of the unique requirements for a shallow draft, stability issues can arise under certain conditions, especially during quick turns. Take time to learn the characteristics of the boat alone and in open water away from other boaters. Make gradual increases in speed and radius to get the feel of stability under various conditions and be ready to make adjustments quickly. Slow down when boating with passengers to avoid possible ejection from the boat.



PROTECTING THE ENVIRONMENT

Our lake, river and ocean resources must be protected to be enjoyed by future generations. Boat owners/operators are responsible for protecting the natural environment and wildlife by keeping waterways clean.

U.S. waters are covered by several water pollution regulations administered by numerous federal and state agencies. Laws vary between local, inland, coastal, ocean and international waters. Laws can be enforced by local and state authorities as well as the USCG. For recreational boats, U.S. Federal Water Pollution Control, Oil Pollution Control and Refuse Acts cover U.S. waters, and the MARPOL treaty covers international waters. In any case, pollution prevention centers around three areas:

- Sewage pollution
- Garbage (solid waste) pollution
- Oil pollution

As a boater, make it a point NOT to dump or discharge ANYTHING into waters and tell passengers to respect this rule. Return all trash after boating and dispose of it properly on shore.

DISCHARGE OF OIL PROHIBITED

The Federal Water Pollution Control Act prohibits the discharge of oil or oily waste into or upon the navigable waters of the United States, or the waters of the contiguous zone, or which may affect natural resources belonging to, or under the exclusive management authority of the United States. If such discharge causes a film or discoloration of the surface of the water, or causes a sludge or emulsion beneath the surface of the water. Violators are subject to substantial civil penalties and/or criminal sanctions including fines and imprisonment.

KC-6020

AQUATIC INVASIVE SPECIES (AIS)



KC-6027

Aquatic Invasive Species (AIS) are plants and animals that occur in waters in which they are not native and whose introduction causes or is likely to cause economic or environmental damage or harm to human health. AIS have a negative impact on the waterway, its native species, and recreational and commercial uses of the waterway. As responsible boaters and citizens, each boat owner should do their part to prevent the spread of these aquatic hitchhikers.

In many cases, it is also required by law. Check local regulations for any waterway where you will boat.



After each boating trip, follow these three simple steps before you leave the water access to stop the spread of AIS: Clean, Drain, and Dry. This is the boater's way to help protect the environment from the damage that AIS can cause.

Clean

- Inspect and remove all aquatic plants, animals, mud, and debris from the boat, engine, trailer, anchor, and any watersports equipment.
- Rinse, scrub or wash, as appropriate, away from storm drains, ditches, or waterways.
- Rinse watercraft, trailer, and equipment with hot water, when possible.
- Flush motor according to owner's manual.

Drain

Completely drain all water from the boat and its compartments, including but not limited to the bilge, wells, lockers, ballast tanks or bags, bait containers, engines, and outdrives.

Dry

Allow the boat to completely dry before visiting any other bodies of water. Water-borne organisms cannot survive long periods of dryness.

NOTE — Some localities may require inspection or decontamination before and/or after launching. Check state and local laws and regulations for requirements prior to traveling to go boating.

PAINTS

Boat owners are responsible for the environmental regulations that may govern the use of antifouling paint. If the boat is kept in water where marine growth is a problem, the use of antifouling paint may reduce the growth rate. Only use antifouling paint that is approved for use with aluminum. Regulations may vary from state to state. Contact local and state boating authorities for specific information.

CLEANING AGENTS

Boat owners are responsible for the environmental regulations that may govern the use of cleaning agents. There are many "green" cleaner choices available for most any material on the boat. If using household cleaners, use them sparingly and never discharge them into waterways. Do not mix cleaners and be sure to use plenty of ventilation in enclosed areas. Avoid using chlorine, solvents and products that contain phosphates, as well as non-biodegradable or petroleum-based products. Regulations may vary from state to state. Contact local and state boating authorities for specific information.

EXHAUST EMISSIONS

Boat owners are responsible for the exhaust emissions from the boat. Increased exhaust (hydrocarbon) emissions, which are regulated by the EPA, pollute the water and air. Contact the dealer and the engine manufacturer for more information. Additional restrictions may apply and vary from state to state. Contact local and state boating authorities for specific information.

Section 4

EMERGENCIES

Be prepared to deal with emergencies before they happen. Try to formulate a plan for each type of emergency in advance in order to make decisions quickly and without hesitation. Precious moments lost can mean the difference between losing and saving a life.

Before operating the boat, review *Safety in Section 2*.

FIRST AID / MEDICAL EMERGENCIES

Every second counts toward preventing injury or death in case of a medical emergency. Boaters must have proper training and take necessary preventive measures to properly assist in times of need. Carrying an adequate and current first aid kit is critical in the immediate response and care of someone in need of medical attention. Always have dry blankets readily accessible to help prevent hypothermia. For additional information on medical, first aid and safety training such as CPR, contact your state and local authorities, or visit the Red Cross website:

<http://www.redcross.org>.

EMERGENCY PREPARATION CHECKLIST

In addition to a safety equipment list, have an emergency checklist on board to assist in times of emergency. Use the following topics as a guideline to develop a list of emergency procedures and instructions for the use of visual and audible distress signaling devices, radios, first aid kits and all related information that could assist you or others in the event of an emergency.

USING DISTRESS SIGNALS

Ensure all passengers understand how to operate all onboard visual and audible distress signaling devices and communication equipment. Keep all distress signaling devices and communication equipment in a readily accessible area and within immediate reach at all times. Seconds count during emergencies. Knowing the proper way to use the distress signaling devices aboard the boat can help save lives.

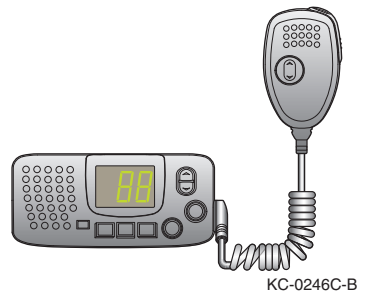



See the *Markers, Warnings and Advisories* section of this manual for more signaling devices.

If your boat is equipped with a VHF radio, there are three primary distress calls:

- **MAYDAY radio call** – A mayday call is reserved for life-threatening situations, such as fire, severe weather or sinking, where lives are in imminent danger or the boat is in danger of sinking. Start the broadcast clearly and calmly with **“Mayday - Mayday - Mayday.”**
- **PAN-PAN (pahn-pahn) radio call** – A pan-pan call is used for urgent but non-life-threatening situations where there is no immediate danger to lives or the boat, such as a loss of steering control or taking on water of any amount. Start the broadcast clearly and calmly with **“Pan - Pan - Pan.”**
- **Securite (se-cure-ih-tay) call** – A securite call is used for non-life-threatening situations to notify authorities and others in the vicinity of important navigation and weather alert calls. Start the broadcast clearly and calmly with **“Securite - Securite - Securite.”**

In an emergency situation the responder needs to know four important pieces of information:

- The exact nature of the emergency and an assessment of the severity
- Number of people on board
- The location (navigation marker, visual reference or GPS coordinates in open water)
- What the boat looks like (hull and top colors, unique features, flags, etc.)

For additional information on the safe and proper use of distress signaling devices and the safe and proper use of emergency communication equipment, contact state and local authorities. Additional information can be found on the USCG website:

<http://www.uscgboating.org>.

REQUESTING ASSISTANCE (NON-DISTRESS CALL)

If a boater contacts the USCG on Channel 16 VHF-FM or Channel 70 DSC regarding a non-distress situation, the USCG will offer to contact any assistance provider (commercial or friend) the boater requests or will issue a Marine Assistance Request Broadcast (MARB) if the boater has no preference of service.



FIRE AND EXPLOSION



WARNING

Fire/Explosion Hazard: Gasoline is extremely flammable and highly explosive under certain conditions.

- Do not smoke or allow open flames or sparks nearby when refueling.
- Do not store fuel in any containers or compartments which are not designated for fuel storage.
- Static electricity can be generated while fueling and can cause a fire or explosion. To prevent electrostatic spark when refueling, make sure the nozzle is in contact with the fill pipe at all times.
- Avoid damaging fuel lines and connectors and make sure fuel does not contact hot engine parts.
- Do not confuse the fuel fill deck plate with the water or waste fill plates, if equipped. All deck plates are properly labeled. If fuel is accidentally pumped into any other deck plate, do not attempt to pump it out. Water and waste pumps are not designed to pump fuel and a fire or explosion could result. Contact the dealer to have the fuel professionally removed.
- USCG-approved fire extinguishers are required on all Class I, II and III boats.

A fire or explosion may occur when least expected. The decision to abandon the boat or stay to fight the fire is difficult and depends on many factors. Formulate a fire plan in advance to make that decision quickly and without hesitation. Keep in mind the following guidelines:

- Many fires are the result of gasoline and oil accumulating in the bilge, careless fueling practices and electrical problems. In the event of a fire, try to stop the boat and turn off the engine as quickly and safely as possible. Immediately use a fire extinguisher at the base of the flames in a sweeping motion to reduce or extinguish the fire. Ensure that all passengers are safe from immediate danger and are wearing life jackets. If the fire is located in the engine compartment (if equipped), make sure the bilge blower (if equipped) is off and do not open the engine cover.
- Once the fire is extinguished, check for other immediate fire threats and personal injuries and call for assistance immediately.



KC-0074C-A



- If you are unable to easily extinguish the fire, or if the fire is uncontrollable, attempt to get yourself and all passengers off the boat and into the water. If possible, ensure that all passengers are wearing life jackets or have access to one by the time they are in the water. Before leaving the boat, if possible, verify that there is no immediate danger of fuel sitting or burning on the water's surface where you and your passengers will be floating. Immediately swim to a safe position upwind from the boat and use distress signals to get assistance.

MAN OVERBOARD (MOB)

A high percentage of boating fatalities are the result of people falling overboard, many of whom were not wearing life jackets. If someone falls into the water unexpectedly, react quickly, as every second counts toward preventing injury or death. Keep these guidelines in mind:

- Brief passengers before leaving the dock on the proper procedures should someone fall overboard. Add this briefing to the passenger safety equipment overview.
- At the first sign that a person has fallen overboard, loudly yell “man overboard” and state which side of the boat such as “man overboard—port!” In heavy seas, throw a floatable item toward the MOB as quickly as possible to serve as a marker.
- The operator should immediately reduce speed and determine whether or not to come to a full stop or circle around.
 - If stopped, throw a flotation device (a throwable type is best, but any can be used) to the victim, shut down the engines, and throw the victim a line if necessary.
 - If circling around, assign one passenger to throw a flotation device as a marker, keep the victim in sight and continuously point to the victim. Carefully navigate back to the victim, staying at a safe distance, and position the boat safely to retrieve the victim. Keep current, wind and waves in mind so the victim drifts toward the boat. Shut down the engines and throw the victim a line if necessary.
- Move passengers to the rescue side of the boat to assist the victim back into the boat.
- Avoid going into the water to assist the victim unless there is no other way to retrieve the victim. If a rescuer must go into the water, the rescuer should be wearing a life jacket. The rescuer should also be prepared for the possibility of being pulled under water by the victim if the victim is panicking.



CAPSIZING AND FLOODING

A boat may capsize or flood when least expected. Formulate a plan in advance in case of capsizing or flooding. Review the following guidelines:

- If the boat capsizes, locate all passengers and guide them to a safe flotation device or the forward hull if the boat is floating upside down.
- If possible, provide life jackets to all persons in the water and assess them for alertness and injuries.
- **STAY WITH THE BOAT!** Climb up on the hull and try to get assistance.
- Do not try to swim to shore, as it can be farther than it appears.

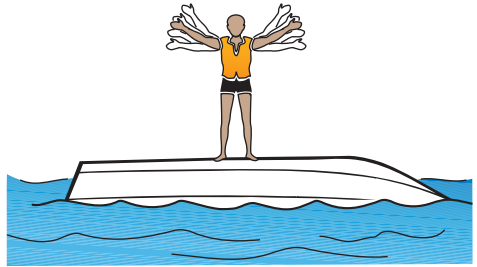

KC-0013C-A

If the boat starts to flood, slow the boat to a safe speed and stop as quickly as possible. Activate the bilge pump(s) immediately. Try to locate the cause of the flooding. If the cause is not readily apparent or not easily corrected, head for shore or shallow water as quickly as possible and call for help.

RUNNING AGROUND

When a boat runs aground, the stop is usually abrupt. Because passengers are not secured to a seat, abruptly stopping a boat while in motion can cause serious personal injury or even death. First, turn off the engine(s) immediately, locate all passengers and attend to any injuries, calling for emergency assistance as needed. Then, assess the damage to the boat and determine if there are any other immediate threats such as water leaking into the boat, or fuel or flammable materials leaking into the water or inside the boat. Immediately call for assistance if threats exist that could endanger the safety of passengers.

If there are no immediate safety threats to passengers and the boat is not damaged, attempt to propel it away from the obstacle. If the engine or drive system has been damaged and the engine restarts, be aware of excessive vibrations or uncommon noises, which usually indicate damage to the drive system. If this is the case, it is not safe to proceed. Call for emergency or professional towing assistance immediately.

**WARNING**

Personal Injury Hazard: DO NOT attach tow lines to cleats, watersport line point, or eyes used for docking; use only designated strong points. Death or serious injury could occur if lines and/or hardware fail while they are under extreme tension.

If the engine restarts and the boat can be navigated safely back to port, proceed slowly to port and be ready to call for emergency assistance if needed. Even if the boat and engine appear to be in good operating condition after running aground, have the boat inspected by a qualified marine technician BEFORE returning it to service. Damage may have occurred that is not obvious to you as an operator.

DANGEROUS WEATHER

Take special precautions when encountering or operating in dangerous or hazardous weather conditions.

See the *Severe Weather* section of this manual for additional information.

ENGINE OR BOAT SYSTEM FAILURE

In the event of an engine or boat system failure and when not in immediate danger, try to troubleshoot or identify the problem before calling for assistance.

See the *Troubleshooting* section of this manual for additional information.

ACCIDENTS, COLLISIONS AND GIVING ASSISTANCE

A collision or accident may occur when least expected. Formulate a course of action in advance in case of a collision or accident. Keep in mind the following guidelines:

- If an accident or collision occurs involving the boat, locate all passengers first and verify and secure their safety. Check for injuries and provide all passengers with a flotation device.
- After determining that passengers are not in danger, provide assistance to passengers on the other boat.
- Immediately call for help and then assess the damage to the boats. Render necessary assistance to prevent further damage or personal injury.

The USCG requires the owner/operator of a boat involved in an accident to report the incident immediately to the proper marine law enforcement agency for the state in which the accident occurred.



See the *Reporting Accidents* section of this manual for additional information.

An operator who witnesses or is aware of an accident or collision while boating must report it immediately and provide assistance.

Operators seeing a distress signal or suspecting a boat is in trouble must assume it is a real emergency and render assistance immediately. After determining that a real emergency exists, call for help immediately and then provide assistance to all passengers to ensure their safety.

TOWING ON THE WATER

In situations where an operator is asked to tow or be towed for any reason, assess the situation and try to contact a professional towing service or other emergency assistance first. When encountering a boat in distress, always offer emergency or safety assistance and/or call for assistance for the distressed parties if necessary. Towing or being towed presents an increased risk of personal injury and boat damage.

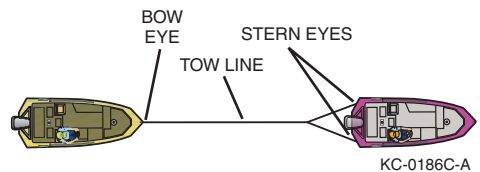

⚠ WARNING *Personal Injury Hazard: DO NOT attach tow lines to cleats, watersport line point, or eyes used for docking; use only designated strong points. Death or serious injury could occur if lines and/or hardware fail while they are under extreme tension.*

Follow these guidelines when towing or being towed:

- Use extreme caution when throwing weighted lines to a boat in distress. When in rough seas, use a light throwing line with a weight secured on the throwing end and a heavier towing line secured to the other end.
- Never attempt to tow a boat larger or heavier than your own.
- Never attempt to tow a grounded, damaged or capsized boat.
- Use a tow line that is rated at least four times the gross weight of the boat being towed.
- Make sure tow lines are in good condition and are free of damage, cuts or abrasions.
- Attach a tow line to the designated strong point on the disabled boat. Never attach a tow line to any point on the disabled boat other than the designated strong point. Strong points are typically the bow and stern eyes on boats under 26' and are usually labeled.
- When attaching to the stern strong points, wrap the tow line with chafing gear where it rubs against the boat or any corners.



- Leave at least two boat lengths between the boats for adequate movement.
- Never allow anyone to be in line with the tow line. If the line breaks, pulls free or the hardware fails, dangerous recoil could occur, resulting in severe injury or death to anyone in its path.
- Adjust the tow line to match wave action. Keep the boats on the crest or in the trough of the waves at the same time. In protected, calm waters, shorten the line for better handling.
- Tow at moderate speed, allowing for adverse wind and wave conditions.
- Have the operator of the towed boat steer with you if possible.
- Have a person on the tow boat watch the disabled vehicle and, if necessary, be available to signal the operator of the disabled boat.

Check with local and state authorities prior to towing for additional regulations and restrictions on towing other boats or equipment.

LAW OF SALVAGE

If boaters require assistance while cruising in the Great Lakes, coastal or ocean waters, they should use caution **before** allowing any towing company or private agency to pass a line to the boat. The law of salvage says, among other things, *“...any vessel, if rendered assistance from a towing company or private agency, can be forced to relinquish a portion of the vessel’s worth for the assistance received.”* While this is very rare with recreational boats, it can happen.

Before taking the line boaters must establish that they do not agree to any salvage rights and wish to be assisted on a contract basis. Boaters must then establish the contract price and payment terms. Boaters should accept the tow line only when the captain of the company/agency acknowledges the contract price and payment. Most tow companies are reputable and post terms and pricing on their websites.

If boating in the Great Lakes, coastal or ocean waters, it is a good idea to have a membership in a national towing service. This membership can significantly reduce the costs of towing if ever needed.



HURRICANE AND SEVERE WEATHER PREPAREDNESS

If keeping the boat in a region susceptible to hurricanes or severe weather (such as in the Great Lakes), have a well-thought-out plan for the boat long before the season starts. Consider the following:

- Boaters new to the area should talk to neighbors and local officials on what to expect.
- Boaters should talk to the dealer and marina about supplies, equipment and services available.
- Assemble the boat, contacts and insurance information and copy documents for safekeeping.
- If keeping the boat on the water, prepare a hurricane mooring package with extra lines, fenders and chafing protectors, as it is usually the boat owner's responsibility to provide mooring gear in a marina. Plan on doubling the normal lines (bow, stern and spring) and fenders as a minimum. Remember, once a hurricane watch is posted, the local supply of lines and fenders will be quickly depleted.
- Remove electronics, canvas and loose items such as fighting chairs.
- Remove flammable, explosive or hazardous materials.

PROTECTING THE BOAT FROM THEFT

Thefts of boats, propulsion units and electronics are on the rise due to the high values and easy resale. While thieves still target boats on trailers at homes or on lake properties, marinas, storage facilities and dealerships are now being targeted because of the concentration of high-quality outboards and electronics available. Consider the following to make it difficult for thieves:

- Remove expensive electronics or cover with a sturdy, lockable cover.
- Use locking devices on outboard motor mounts and propellers.
- Use security fasteners that require a special tool for removal when mounting devices.
- Survey the marina or storage facility for obvious security lapses. Discuss concerns with personnel or find a new location.
- Talk to neighbors at home or the marina/storage facility and provide them with a cell phone number and other contact information.
- If leaving the boat in the water, install a boat monitoring system with GPS tracking. Many propulsion unit manufacturers now offer this as an option on boats with electronic controls.
- Consult an insurance agent and local authorities for more recommendations.



SECTION

4

EMERGENCIES

This Page Intentionally Left Blank

Section 5

OPERATING IN HAZARDOUS CONDITIONS

Before operating the boat, review *Safety in Section 2*.

SEVERE WEATHER

Getting caught in severe weather can be dangerous and even fatal. Check with local weather stations, the USCG or weather-service broadcasts (162.55 or 162.40 MHz) for the latest conditions. Check the weather not only before you go out on the water, but also periodically while you are on the water. Consult the following websites for weather information:

- www.weather.com
- www.weather.gov
- www.navcen.uscg.gov

Enable National Oceanic and Atmospheric Administration (NOAA) weather alerts on radios, phones and other electronic devices for advance warnings. If weather is approaching, instruct all passengers to wear a life jacket; close all windows, hatches and doors; remain seated; use handholds and seek shelter in a safe harbor.

STORM CONDITIONS

Take the following precautions if operating the boat in storm conditions:

- Have all occupants wear life jackets.
- Turn on navigation lights.
- Locate and have inclement weather gear and safety equipment ready.
- Mark or identify the boat's position.
- Close all ports, stow all gear and secure any loose equipment on deck.
- Reduce speed and head for port or a safe, easily reachable place.
- Keep a lookout for debris and obstructions in the water.
- When possible, head into the waves at a 45-degree angle. Allowing high waves to strike the side of the boat may cause it to capsize or swamp.
- If losing power, keep the boat headed into the waves by rigging a sea anchor off the bow.
- If a storm cell with lightning cannot be avoided, lower antenna and take down fishing poles.



FOG CONDITIONS

Avoid operating the boat in foggy weather, if possible. Operators encountering fog conditions should return to port immediately. Also, take the following precautions:

- Reduce speed to a safe speed or idle.
- Take bearings and log the course and speed before the fog sets in. Use of a GPS is recommended.
- Have all occupants wear life jackets.
- Assign lookouts to the bow and stern to keep watch and listen.
- While navigating in fog, sound a five-second blast from the horn or whistle once every two minutes to alert other boaters of your position.
- If it is unsafe to continue navigating the boat, quickly find the best position to anchor. Sound a five-second blast from the horn or whistle once every minute while anchored to alert other boaters of your position.

REDUCED VISIBILITY

Natural environments and inclement weather can cause reduced visibility. Storm condition hazards can be compounded by reduced visibility while on the water. Always use common sense and take safety precautions if operating the boat in reduced visibility conditions.

COLD WEATHER

Avoid operating the boat in cold water or weather conditions, and never operate in frozen or icy waters. Operating in these conditions significantly increases the risk of serious injury or death. Boating in these conditions can lead to cold-water immersion, shock or hypothermia. Weather conditions may hinder emergency rescue or assistance, and cold weather poses potential problems for onboard equipment, as well as the engine. See the *Engine Operator's Manual* and the equipment manufacturer's instructions for operating in cold weather.

WATER HAZARDS

Every waterway poses hazards that operators must be aware of and avoid. These hazards include shallow water, rocks, tree stumps, sandbars and submerged/semi-submerged cables and pipes. Ask local authorities and other boaters for information and consult a marine chart when boating on unfamiliar waters. As a boat operator, try to avoid all hazards, known and unknown.



AQUATIC VEGETATION / WEEDS

Operating in weeded areas can be hazardous. Aquatic vegetation can be a threat to the boat's drive system. Vegetation and weeds can wrap around the propeller, causing loss of propulsion and steering control. They may also restrict the engine water cooling intake, causing the engine to overheat. Avoid operating in or near vegetation. If restricted because of vegetation, stop the engine. See the *Engine Operator's Manual* for recommendations on the removal of vegetation from the propeller and water cooling intake ports. Be extremely careful and never get into the water when clearing the propeller. Stay out of the water in highly congested vegetative areas, which can severely restrict your mobility and create a life-threatening situation.

NOTICE

Vegetation can sometimes be removed by shifting to NEUTRAL, pausing a moment, then shifting to REVERSE to unwind the vegetation from the propeller.

DAMS AND SPILLWAYS

The waterways around dams and spillways are extremely hazardous. Dams and spillways are subject to rapid water flow changes, and may have floating and sunken debris in the nearby water. These areas are often marked as restricted, and it is best to always stay clear of them.

SHALLOW WATER OPERATION



WARNING

Collision Hazard: Use caution in shallow water or where underwater/floating objects may be present. Hitting an object at high speed or severe angle can seriously injure people and damage the boat.

Operating in shallow water presents a number of hazards. Sandbars in narrow inlets are constantly shifting, making it difficult to mark them with buoys. Sandbars are sometimes indicated by waves as they form into breakers when passing over the sandbar. In coastal areas, tides can affect water level as much as 30 feet (9 meters). Check with local marinas or Coast Guard stations for tide tables and current charts.



MARKERS, WARNINGS AND ADVISORIES

Find out from local authorities if hazards exist in areas where you intend to navigate, and know how these hazards are marked. You must also recognize flag designs that indicate hazards or activities that are present and keep well clear of those areas. Always watch for swimmers and stay clear of all swimming areas, marked or unmarked.



KC-0015C-B

Become familiar with navigation markers, which identify navigable routes and indicate water hazards. Always stay within marked boundaries and steer clear of hazards.

Flags and indicators are markers of potential emergencies and hazards. Become familiar with these flags and indicators. Additionally, understand your responsibilities when operating at these times and in these areas.

BOAT FLAGS

DIVERS FLAG



USED BY
RECREATIONAL
DIVERS -
INDICATES
DIVER'S
POSITION

ALPHA FLAG



WORLDWIDE VESSELS
ENGAGED IN DIVING
OPERATIONS - DOES
NOT INDICATE
DIVER'S POSITION

DISTRESS FLAG



INDICATES
FELLOW
BOATER IS IN
NEED OF
ASSISTANCE

SKIER DOWN FLAG









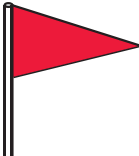

INDICATES
SKIER IS DOWN

KCB-0013

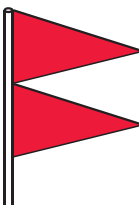
Storm warning advisory flags and indicators alert boaters to impending weather conditions. Become familiar with these flags and indicators and understand the potential hazards associated with operating in these conditions.



HARBOR FLAGS AND INDICATORS

DAYTIME WARNING	DESCRIPTION	NIGHTTIME WARNING
	Small Craft Advisory - Winds greater than 18 knots, sustained for two hours or more or hazardous wave conditions. Following a storm, hazardous wave conditions can persist long after the high winds have subsided.	
	Gale Warning - Sustained winds (2 or more hours), of 34-47 knots.	
	Storm Warning - Sustained winds of 48 knots or greater.	
	Hurricane Warning - Forecast winds of 64 knots and above. Displayed only in connection with a hurricane.	

 Actual Signal in red

KC-0371C



SECTION

5

OPERATING IN HAZARDOUS CONDITIONS

This Page Intentionally Left Blank

Section 6

NAVIGATION RULES AND AIDS

Before operating the boat, review *Safety in Section 2*.

The following information outlines basic navigational rules. Boating regulations are enforced by USCG, state and local authorities. You are subject to marine navigation regulations for both federal and state waterways. For more information, contact the USCG, state and local marine authorities. The navigational rules for U.S. waterways can be found in the “Navigational Rules” publication. This publication can be found at most marine supply stores, or you may contact the USCG or visit:

www.navcen.uscg.gov to view or download the publication.

RULES OF THE ROAD

RIGHT-OF-WAY

Boats with less maneuverability have right-of-way over more agile boats. You must stay clear of a boat with right-of-way. Examples of boats with right-of-way are:

- Boats aground or not under command
- Boats with restricted maneuverability
- Boats engaged in fishing
- Non-motor boats (having no power propulsion), i.e., rowboats, paddle boats, canoes and sailboats

Small pleasure boats must yield right-of-way to large commercial boats in narrow channels. A boat with right-of-way is sometimes referred to as the privileged boat.

The General Prudential Rule

The general prudential rule regarding right-of-way is if a collision appears unavoidable, neither boat has right-of-way. Both boats must act to avoid collision.



CROSSING

In crossing situations, the boat to the right from the 12 o'clock to the 4 o'clock position has the right-of-way and must hold course and speed. The boat without right-of-way must yield and pass to the stern of the privileged boat. Boats going up and down a river have the right-of-way over boats crossing the river.

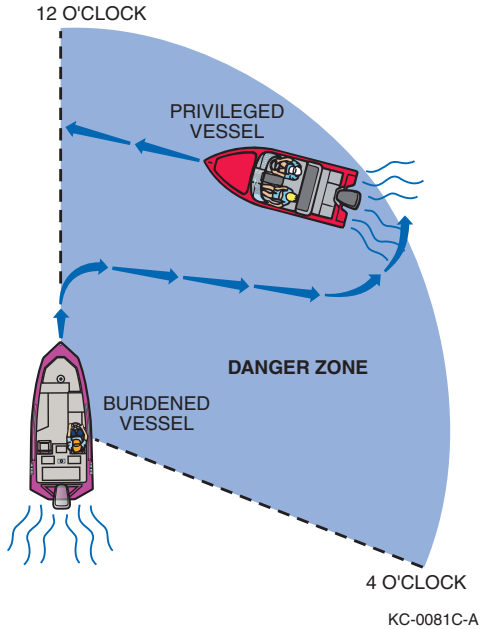

NAVIGATION RULES AND AIDS



MEETING HEAD-ON

When two boats meet head-on, neither boat has the right-of-way. Both boats should decrease speed, turn to the right and pass port to port. If, however, both boats are on the left side of a channel, each vessel should sound two short horn blasts and pass starboard to starboard.

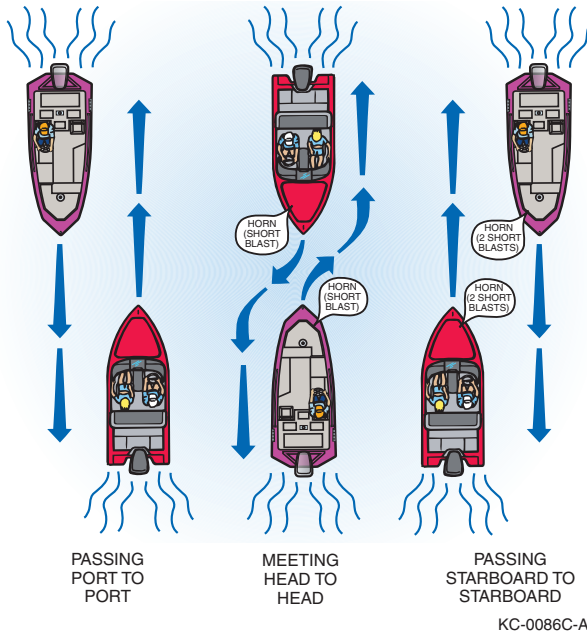



OVERTAKING / PASSING

The boat overtaking or passing must yield right-of-way to the boat being passed. The overtaking boat must make any adjustments necessary to keep out of the way of the boat being passed. The boat being passed has the right-of-way and must hold its course and speed.

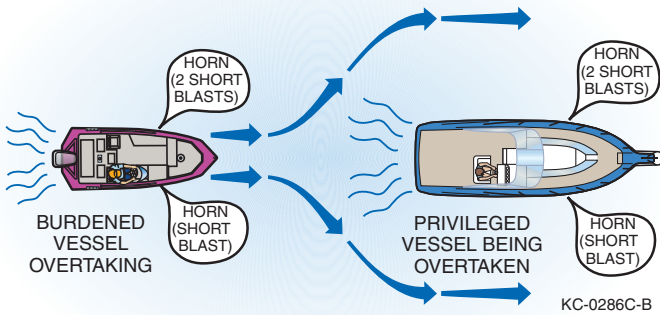

AUDIBLE SIGNALS

It is not necessary to sound a signal every time a boat is nearby. It is typical for commercial boat operators to signal their intention, using a whistle, horn or bell, to avoid potentially confusing or hazardous situations. Privileged boat operators customarily signal first, then the yielding boat operators return the same signal to acknowledge they understand and will comply. Use the danger signal (five or more short, rapid blasts) if intent is not clear.

Use the following signal blasts early enough so other boaters notice and understand them:

AUDIBLE DISTRESS SIGNAL	DEFINITION
One long blast	Warning signal (coming out of slip or passing astern)
One short blast	Pass on port side
Two short blasts	Pass on starboard side
Three short blasts	Engine(s) in reverse
Five or more short blasts	Danger signal



AIDS TO NAVIGATION

Learn to recognize the different buoys and day markers; they are the signposts of the waterways. The United States Aids to Navigation System (USATONS) is the primary marking system used on inland water, coastal waters and rivers. This system is maintained by the USCG.

There are two other navigation marking system variations boaters must follow in the United States:

- Western Rivers Marking System – When on the Mississippi River, tributaries above Baton Rouge, and several other rivers that flow toward the Gulf of Mexico.
- Intracoastal Waterway (ICW) – Runs just inland and parallel to the Atlantic Ocean and Gulf coasts from Manasquan, New Jersey, to the Mexican border. *Since ICW routes may travel next to non-ICW routes in opposing directions, navigate by the yellow symbols when following the ICW.*

Both systems are similar to USATONS but have subtle differences that must be understood. If you boat in these areas, visit www.uscgboating.org for navigation rules.

Navigational aids are designed and placed accordingly to help you navigate safely on the water. Learn to recognize the different buoys and day markers.

The following information is based on the USATONS. For further information, contact the USCG and state and local marine authorities. Also visit www.uscg.boating.org for navigation rules.

The USATONS uses buoys, beacons and minor lights as markers.

NEVER tie or anchor to a navigational aid. This action is unlawful and dangerous to you, your boat and other boaters.

NEVER move or damage a navigational aid. This action is unlawful and dangerous for other boaters.

BUOYS

Most anchored floating markers are generally referred to as buoys. Buoys have many uses and color schemes, and can vary in size and shape. The most commonly used buoy colors are white, red, green, yellow and black. Buoys may be unlighted or lighted. Some are audible; others have both an audible and a visual signal. Lights, bells and horns on buoys aid in night boating or poor visibility conditions. Buoys with unique light-flashing characteristics are identified on nautical charts with the specific flashing pattern.



Become familiar with the specific buoys used in the waters where you are boating. Contact local authorities for specific information and/or navigational aid charts for your waterways.



UNLIGHTED
BELL BUOY



SPAR BUOY



CAN BUOY



LIGHTED BUOY



NUN BUOY



SPHERICAL SAFE
WATER MARKER

KC-0052C-B

Mooring Buoys

The only buoys you are permitted to moor to are mooring buoys. Mooring buoys are white with a blue horizontal stripe. Check with local authorities before deploying a permanent mooring buoy. Mooring to a navigation buoy, regulatory markers or lateral markers is illegal.

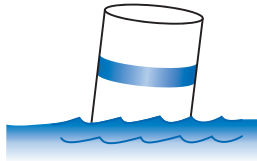

WHITE WITH BLUE BAND

MAY SHOW WHITE
REFLECTOR OR LIGHT

KC-0020C-A

DAYMARKS / DAYBOARDS

Daymarks or dayboards are fixed visual markers in the water. The markers are commonly attached to a post or piling and are sometimes accompanied by a light. Daymarks are either red or green and are usually triangular- or square-shaped, though their shapes can vary. Daymarks often display numbers, which act as navigation guides. Red daymarks are usually triangular and sometimes show an odd number. Green daymarks are usually square and sometimes show an even number. The numbers on the markers are sequential and increase from seaward.

STARBOARD
DAY
MARKER



PORT
DAY
MARKER



KC-0021C-A



LIGHTS AND LIGHTED STRUCTURES

Maneuvering a boat at night can be dangerous and confusing. To aid boaters with navigation and to warn of hazards, the USCG and state and local authorities maintain a variety of light structures. Some light structures are equipped with radio beacons, radar reflectors and/or fog signals.

Minor Lights

Minor lights are colored according to the buoyage marking system in use. They are similar to lighted buoys, except they are usually higher and on more stable platforms to increase visibility. Most minor lights are part of a series to mark a channel, river, or harbor and fairways.

Range Lights

Range lights are usually visible in one direction and help a boat operator navigate safely. Steering a course to keep range lights arranged in a line (one on top of the other) will help guide a boat through a channel.

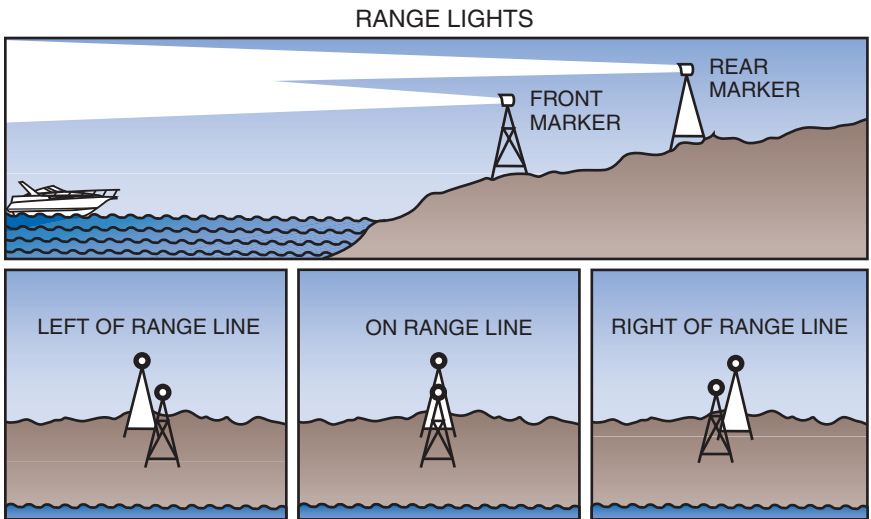

KC-0022C-A



Lighthouses

Lighthouses can be found at harbor entrances, prominent headlands, isolated danger areas and along the coasts. These striped or patterned structures have unique flashing signals, which help boaters identify them.

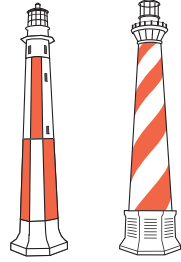

KC-0023C-B

MARKERS

Seven (7) types of markers are used to assist the boat operator:

- Regulatory
- Range
- Special
- Lateral
- Safe Water
- Preferred Channel
- Isolated Danger

Regulatory Markers

Regulatory markers are used to display information or indicate danger. Regulatory markers can be fixed visual markers or anchored floating buoys.

Fixed visual markers are usually white with orange geometric shapes that display information. Anchored floating buoys are white cylinder-shaped buoys with orange bands at the top and orange geometric shapes that may display information.

Following are the various orange geometric shapes used on these markers:

- Diamond – Indicates danger
- Diamond with cross marks inside – Indicates that a boater must keep away
- Circle – Indicates a controlled area or speed limit
- Square – Displays important information



DANGER



BOATS
KEEP OUT



CONTROLLED
AREA



INFORMATION

KC-0244C-A

Range Markers

Range markers have many color schemes, may have numbers or letters and may be lighted or unlighted. They are placed in pairs within close distance of each other. They are commonly used in channels to guide boats safely through the center or safe line of navigation. Keep range markers visually in line with each other while navigating the waterway to avoid obstacles or other invisible dangers.

Special Markers

Special markers are yellow and come in various styles and shapes. Lighted and unlighted daymarks and buoys vary in function. Many are used to display information and navigational direction rules. The most common special markers are those used in intercoastal waterways. Contact your state and local authorities for more information on special markers used in your boating area.



Lateral Markers

Lateral markers are used to mark the sides of navigable channels. They can be buoys, daymarks or minor lights, and are red and green in color. They can be lighted or unlighted and may or may not have numbers.

The basic nautical rule of lateral markers is the phrase “Red, Right, Returning.”

The term “sea” generally refers to the ocean or a large body of water. “Seaward” refers to traveling or pointing toward the sea or large body of water. “From seaward” refers to traveling from the sea or a large body of water inland or toward a smaller body of water.

When traveling seaward – keep red markers to your port (left) and green markers to your starboard (right).

When returning from seaward – keep red markers to your starboard (right) and green markers to your port (left).

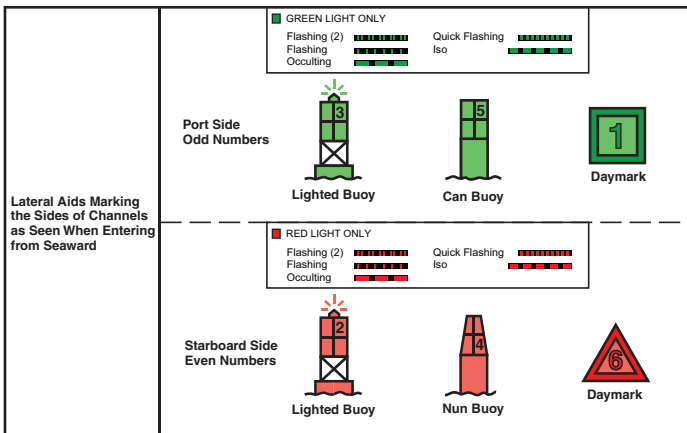

KC-0054C-A



Safe Water Markers

Fairways and mid-channels may be marked with safe water markers or buoys. These markers indicate safe water all around. Safe water markers are red and white with vertical stripes, and are round or have a red spherical top mark.

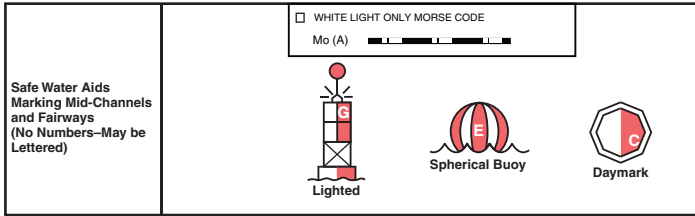

KC-0055C-A

Other Special Signs and Markers

Various signs and markers are used throughout U.S. waterways for different purposes. In Florida, special signs are used to warn of “manatee” areas. These signs help to control speed and/or restrict areas from boating to conserve this endangered species. As a boat owner and operator, be aware of special information and markers on the waterways. Contact your state and local authorities for more information on local restricted or controlled areas and their markers.



Preferred Channel Markers

Obstructions, channel junctions and preferred channels are marked with red and green horizontally striped can and nun-style buoys. The top band color indicates the preferred path to take. Use these markers in the same manner as lateral markers to follow preferred channels.

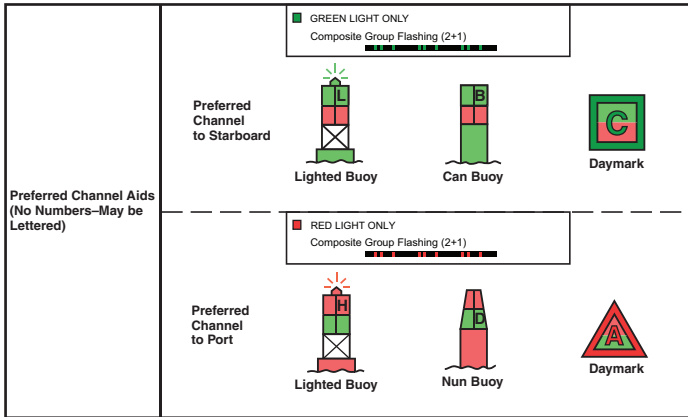

KC-0056C-A

Isolated Danger Markers

Isolated danger markers indicate an isolated danger which may be passed on all sides. These markers are black with one or more broad horizontal red bands and are equipped with a top mark of two black spheres, one above the other. On inland waters, a buoy with alternating vertical black and white stripes may be used to indicate that an obstruction or other danger exists between the buoy and the nearest shore. Do not pass between the buoy and the shore.

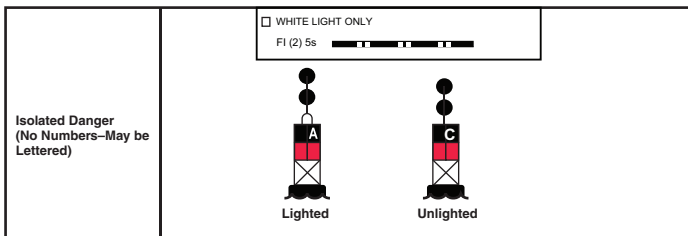

KC-0057C-A



NAVIGATIONAL LIGHTS AND NIGHT OPERATION

Navigational lights are intended to alert other boats to your presence and course and their use is essential to boating safety and the prevention of collisions. Knowledge of navigation lights is necessary for the boat operator.

Regulations require that navigational lights be clearly lit and properly displayed at all times between sunset and sunrise, and always when operating in reduced visibility. Where applicable, lights must appear on the sides, stern, masthead and all-around positions. While underway, especially in congested areas, turn off any show lighting and lighted accessories.

All navigational rules apply at night, but speed is restricted on many waterways. Night boaters must operate at a slow, safe speed and stay clear of all boats, regardless of which boat has right-of-way.

Protect your night vision by avoiding bright lights and dimming courtesy lights. If possible, have a passenger help keep watch for other boats, water hazards, and aids to navigation.

The size, speed and direction of other boats are determined at night by white, green and red running lights.

- A green light indicates the starboard side of the boat. Generally, if you see a green light on another boat, you have the right-of-way. Hold your course.
- A red light indicates the port side of the boat. Generally, if you see a red light on another boat, they have right-of-way and you must yield your course.
- If you see both red and green lights, this indicates the boat is pointed towards you. Reduce speed and give a wide berth, usually on your port.
- A white light alone with no visible red or green lights indicates a boat at anchor and not making headway or a non-powered craft. Reduce speed and give a wide berth.

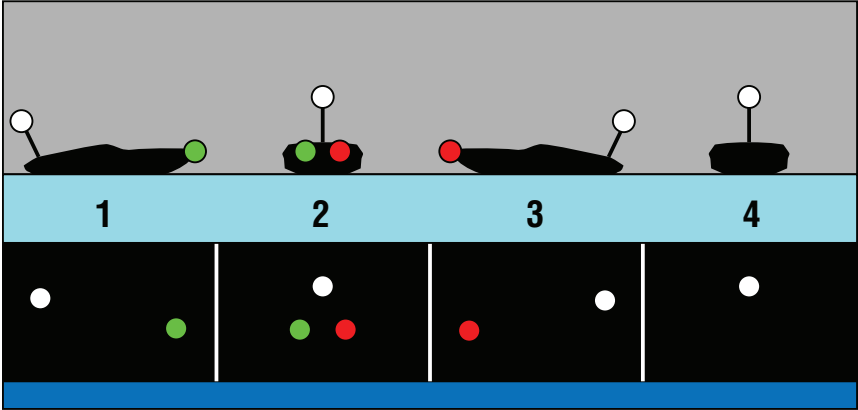

KCB-0104

1. Starboard Side; boat moving to the right
2. Bow; boat moving towards you
3. Port Side; boat moving to the left
4. Stern; boat anchored, non-powered or moving away

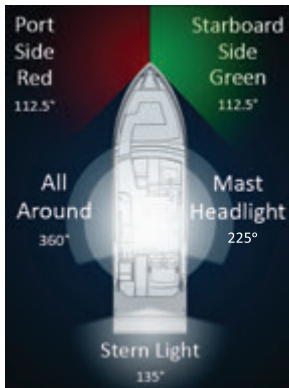

KCB-0105

Section 7

OPERATING THE BOAT

Before operating the boat, review *Safety in Section 2*.



WARNING

Control Hazard: Certain actions can cause you to lose control of the boat:

- *When accelerating the boat in the forward direction, the bow can rise and restrict visibility. Observe for obstacles and people before accelerating.*
- *The rotational thrust of the propeller under rapid acceleration can create high steering torque and rapidly change the direction of steering, causing loss of control.*
- *Do not trim the engine out too far or the boat may begin to “porpoise” (bounce up and down). Porpoising reduces control and visibility.*
- *Improper use of trim tabs or moving them down at high speeds can cause loss of control.*
- *If you lose control of the boat, pull back on the throttle and trim in at the same time.*

BEFORE GETTING UNDERWAY

SAFETY EQUIPMENT

Federal and local laws require certain safety equipment to be on board at all times. Responsible boaters carry additional equipment in case of emergency.

FLOAT PLAN

Complete a float plan before departure and leave it with a reliable person who is aware of your intentions while on the water. In case of emergency or if you do not return as planned, this information can be helpful to the USCG or others in rescuing or contacting you. There are several float plan apps that make it easy to fill out and email the plan. For more information on float plans or to download a float plan form, go to:

<https://www.floatplancentral.cgaux.org>



PRE-DEPARTURE SAFETY CHECKLIST

The following checks are essential to safe boating and must be performed before starting the engine or getting underway. Perform these checks every time you operate the boat so they become routine.

Never launch the boat or leave the safety of the dock if any problem is found during the pre-departure safety check. A problem could lead to an accident during the outing, causing severe injury or death. Have any problems corrected before proceeding:

- Check the current and forecasted weather reports, as well as wind and water conditions.
- Make sure the operator is qualified to operate the boat and does not use drugs or alcohol while at the helm.
- Make sure all required safety equipment is on board.
- Make all passengers aware of safety procedures.
- File a float plan.
- Have all required documents on board.
- Have all maps or navigational charts for the intended destination on board.
- Be sure all passengers are properly seated.
- Be sure the boat is not overloaded.
- Check the engine emergency stop switch lanyard for proper installation and operation.
- Be sure the fire extinguisher is fully charged.
- Check bilge drain plugs for proper installation.
- Be sure all water has been pumped from the bilge area.
- Have plenty of emergency food and water on board.
- Check the bilge blower (if equipped) for proper operation, and be sure no fumes are present in the bilge area.
- Be sure all required equipment is on board (mooring lines, anchor lines, tool kit, etc.).
- Be sure you have enough fuel for the return trip.
- Check all compartments for fuel fumes.
- Check that no fuel, oil or water is leaking or has leaked into the bilge compartment.
- Check all hoses and connections for leakage and damage.
- Check the hull and propeller for damage.
- Check the engine cooling water intake pickup for blockage.
- Check that batteries are fully charged and the battery terminals are clean and tight.



- Check the electrical systems and navigation lights for proper operation.
- Be sure no person or obstacle is near the propeller.
- Check that the throttle/shift control is in the NEUTRAL position.
- Check the steering system for proper operation.
- Inspect the steering, throttle and shift cables for kinks, wear and interference with other components.
- Check that all required maintenance has been performed.

BOARDING

Helpful guidelines when boarding a boat:

- Always step, rather than jump, into a boat.
- Avoid stepping on fiberglass or other potentially slippery surfaces.
- Always board one person at a time.
- Never board while carrying gear. Set the gear on the dock, board the boat and then pick up the gear.
- Never use the engine unit as a boarding ramp.
- It is courteous to always ask for permission to board so the owner/operator is aware of your presence on the boat.
- Always face the boat when boarding/re-boarding using a ladder.

See the *Using the Platform/Boarding Ladder* section of this manual for re-boarding the boat from the water.



BOAT LOADING

The safety and performance of the boat depends on load, weight and the distribution of each.

The person/load capacity is determined by the USCG. A capacity plate is usually located within clear visibility of the boat operator or helm area. The capacity plate indicates limits for loading the boat, which are enforceable by law.

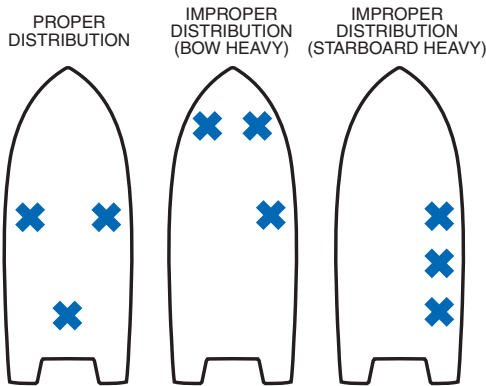

KC-0333-A



WARNING

Sinking Hazard: NEVER exceed the USCG certified maximum capacities under any circumstances. Exceeding the limitations stated on the capacity plate can cause the boat to sink or the passengers and/or operator to drown, resulting in death or serious injury.

- Board passengers one at a time and distribute them equally to maintain equal buoyancy of the boat.
- Distribute weight equally from port to starboard and fore to aft. The shifting of weight may be required when underway to maintain an efficient trim position for optimum performance.
- Stow and secure all loose gear in stowage areas to prevent load shifting.
- Do not stow gear on top of safety equipment; safety equipment must be quickly accessible.
- In adverse weather, reduce the load in the boat. Person and load capacity ratings are calculated for normal boating conditions.



FUELING

FUEL MANAGEMENT

Use the “one-third” rule for fuel management. Use one-third of the fuel to reach your destination, one-third to return and one-third as reserve fuel.

FUEL SUPPLIERS

Refuel only at approved suppliers such as marina fuel docks or automotive fuel service stations. Approved suppliers have safeguards in place to lessen the likelihood of static discharge. Use only containers and funnels approved for use with the fuel type. See the *Before Refueling* section of this manual for additional information.

STATIC ELECTRICITY AND THE FUEL SYSTEM

The boat’s built-in fuel tank has a bonding system that protects it from creating and discharging static electricity. The boat must be in contact with the water or on its trailer when refueling to complete the bonding system.

If the bonding system is not complete, an electrostatic spark may occur.

 **WARNING** *Fire/Explosion Hazard: An electrostatic spark can ignite fuel vapors, causing a fire and/or explosion.*

Use extreme caution when filling the fuel system. In addition:

- Remove portable fuel tanks from the boat and place them on the ground to fill. The fuel tank must be properly grounded before refueling. If keeping portable tanks on board, store them only in a ventilated compartment. Never store them in an engine compartment or near heat/flame-producing accessories.
- Do not refuel a built-in fuel tank if the boat is suspended from a sling or another type of boat lift system. Suspending the boat from the water interrupts its bonding system. Using a portable fuel tank to refuel the boat while it is suspended may cause an electrostatic spark.



FUEL (GASOLINE)

Fuel for marine gasoline-only engines must be carefully selected to avoid fines and possible catastrophic engine damage not covered under warranty. It is illegal for any person to tamper with emissions control devices such as the fuel system, and it is also illegal for any person to mis-fuel a marine gasoline-only engine with a blend of more than 10% ethanol.



While it is always preferable to use fuel that does not contain ethanol (usually labeled as “marine” or “recreational”), most marine engines are designed to tolerate E10 (10% maximum ethanol) fuel as long as the fuel meets the engine manufacturer’s octane requirements. When using fuel containing ethanol, buy fuel in smaller quantities that will be consumed during the boating session with a 10% reserve. Fuel degrades quickly and the engine operates better on fresh fuel. Use marine fuel stabilizer to treat and reduce degradation of any remaining fuel.



Fuels that contain bio-isobutanol at any percentage are safe to use in marine products and have none of the limitations of ethanol biofuel additives.

Do not use octane boosters or other fuel additives except marine certified fuel stabilizer. Purchase fuel from a quality supplier selling high volumes to ensure the fuel is fresh. For more information go to: www.toptiergas.com/licensed-brands/

NOTICE

Fuels that are blended to contain more than 10% ethanol may damage the engine, oil system or fuel system and should not be used in marine engines. Fuels that contain more than 10% ethanol can corrode metal parts, deteriorate rubber and plastic, or weaken gaskets. Damages caused by the use of fuels that contain more than 10% ethanol or fuels that do not meet engine manufacturer octane requirements are not covered by your warranty.



Gasoline Fuel in the U.S. Market

The majority of recreational boats are trailerable and often fueled at automobile gasoline filling stations. In the U.S. market, there are ever-increasing percentages of ethanol blended with gasoline with the most common being 10%. Since there is no standard for labeling gas pumps, it can be confusing to select the proper blend – LOOK BEFORE YOU PUMP!

Ethanol blends of more than 10% are tempting to use in your boat because they are cheaper. Ethanol blends of more than 10% are NOT meant for ANY outdoor power equipment and their illegal use will not only deteriorate rubber and plastic, causing an environmental hazard, but will cause permanent DAMAGE to the engine that is not covered by the Warranty – DO NOT BUY GAS BY PRICE!

	CONTAINS NO ETHANOL	UP TO 10% ETHANOL	UP TO 15% ETHANOL	UP TO 30% ETHANOL	UP TO 50% ETHANOL	UP TO 85% ETHANOL
OK for Boat Engines	Yes	Yes**	No	No	No	No
OK for Long-Term Storage	Yes*	No	No	No	No	No
Covered by Engine Warranty	Yes	Yes	No	No	No	No
Illegal to Use in Boat Engines	No	No	Yes	Yes	Yes	Yes
Price	Most Expensive	About 5% less	About 10% less	About 20% less	About 30% less	Least Expensive

* 3 – 6 months with marine-grade fuel stabilizer *added immediately*

** Not more than one month with marine-certified marine-grade fuel stabilizer *added immediately*



BEFORE REFUELING

WARNING *Fire/Explosion Hazard: Gasoline is extremely flammable and highly explosive under certain conditions. Be sure to check the fuel hoses and connectors for leaking and deterioration before fueling and on a monthly basis.*

- Refuel the tanks only in a well-lighted area.
- Know where the fire extinguishers are.
- Stop all engines, motors, blowers and appliances before refueling.
- Do not smoke or allow open flames or sparks nearby, within 50 feet (15 meters), of the fueling area.
- If equipped, close all doors, windows, hatches and ports.
- Determine the amount of fuel required to fill the tanks. Fuel expands as the ambient temperature increases; do not overfill the fuel tank. Allow for at least a 6% expansion of fuel when refueling.

REFUELING

The fuel filler on boats with built-in tanks is usually located on the gunwale or aft area. The fuel tank is equipped with either a fuel demand valve or antisiphon valve. Both valves operate automatically. Because gasoline fumes are heavier than air, they will sink to the lowest part of your boat, such as the bilge. Always refuel in a well-ventilated area. If refueling with an automatic shutoff nozzle, do not allow unattended fueling and stop fueling when the nozzle shuts off. Adding more fuel can overfill the system, causing emission components to malfunction.

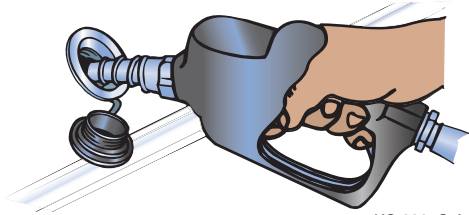

KC-0027C-A

NOTICE

To prevent unwarranted engine damage, refer to the Engine Operator's Manual for recommended fuel and oil specifications.

CAUTION *The fuel tank may be under pressure. Remove fuel filler cap slowly to release any pressure.*



REFUELING BUILT-IN FUEL TANKS

When refilling a permanent fuel tank from a land-based fuel nozzle with the boat out of the water, maintain contact between the fuel nozzle and the fill pipe at all times, before and during refueling, to prevent an electrostatic spark. If it's necessary to use a funnel, use a metal funnel. Do not use a plastic funnel. Do not fill built-in tanks from unapproved portable containers.

When refilling a permanent fuel tank from an approved portable fuel container with the boat in the water, a plastic funnel may be used.

NOTICE

If the boat is unlikely to be used for two weeks or more, and you are using an ethanol-blended fuel, fill only the amount of fuel you need plus 10% as a safety factor. Unused ethanol-blended fuel deteriorates quickly.

AFTER REFUELING

- Close the fuel fill cap thoroughly.
- Wipe up any spilled fuel completely. Dispose of rags properly onshore.
- Open all doors, windows, hatches and ports to ventilate all spaces. Check for fuel vapors before starting any engines or appliances.
- If equipped, operate the blower for a minimum of four minutes before starting the engine.

OUTBOARD ENGINE FUELING CONSIDERATIONS

If the boat is powered with an outboard engine, one or more of the following may also apply:

- Smaller two or four-stroke outboards may have a portable fuel tank. If so, the tank must be removed from the boat and placed on the ground to be filled. Fill portable fuel tanks onshore in the outdoors within an enclosed area.
- After refueling, install portable fuel tanks to the boat using straps or other fuel tank restraining system. Store portable fuel tanks in a well-ventilated area, away from heat and open flames. If equipped, close the filler cap vent screw.
- Two-stroke outboards mix oil with the fuel to be burned during combustion. During fueling and refilling on a two-stroke outboard, check the separate oil tank inside the boat or under the engine cover.
- Two-stroke outboard oil must meet the engine manufacturer's specification.



GETTING UNDERWAY

The following basic boat maneuvering and operation principles do not cover all conditions or situations you may encounter during operation. It is important for you and anyone else operating the boat to have certified instruction before operating the boat.

Always advise all passengers on board of your steering, stopping and accelerating intentions. Brief passengers on:

- Obeying captain's orders
- Safety equipment location and operation
- Basic boat operation
- Radio operation
- Re-boarding procedure
- Man overboard procedure
- Emergency procedure
- Hazardous weather procedure
- Docking procedure
- Fueling procedure

Be sure all passengers are properly seated in designated seating positions and not riding on the bow, bow pulpit, deck, gunwale or rear sun deck while underway. Passengers must use caution when riding in the bow. Move to the aft passenger seats during rough water operation or if visibility is restricted. Check that any gates, dive doors or hydraulic beach doors are closed, and that platforms and boarding ladders are up and locked in position.

STARTING

The following information is intended as a basic guideline only and may not apply to your specific engine or controls. See the *Engine Operator's Manual* or control manufacturer's information for instructions on starting and operating the engine, adjustments and maintenance.

- Secure the boat to the dock before starting the engine.
- Check that the throttle is in the NEUTRAL position.
- Turn the battery selector switch to the appropriate ON position.
- Attach the engine emergency stop switch lanyard to the boat operator.
- Check that all passengers are seated properly.
- Position the lower drive power trim to the full DOWN position.
- Start the engine.



STEERING



WARNING

Control Hazard: *If the engine is shut off (no thrust), you will have no steering control, and the boat's momentum will cause it to move forward even though the engine has stopped. Even at low engine speeds where thrust is reduced, a loss of steering control can occur.*

Steering a boat is very different from steering an automobile. Steering and maneuvering a boat is far more difficult and requires time and practice to master.

When steering a boat, it is important to understand the causes and effects of turning. Since both thrust and steering are at the stern of the boat, the stern will push away from the direction the steering wheel (helm) or tiller arm is turned. The boat seems to skid across the water while turning, which feels very different from an automobile making a turn.

Steering in reverse has its own challenges. Practice forward and reverse steering to gain comfort and to feel in control of the boat in any steering situation.

Be prepared for wind and current while steering the boat. Steering in wind or water currents is difficult and requires skill to be able to anticipate and compensate for these effects.

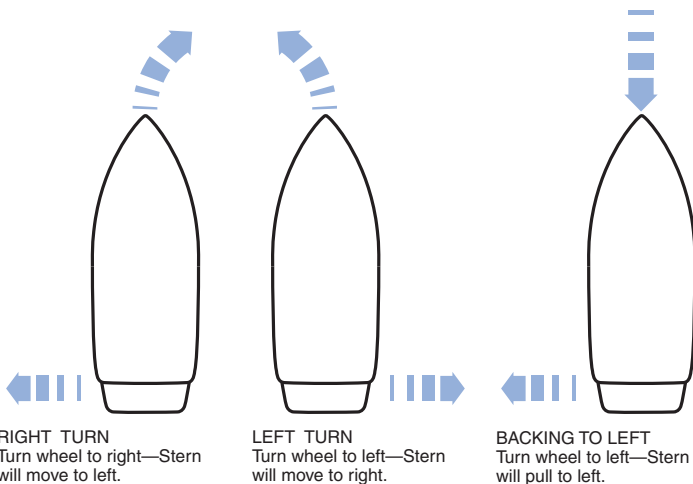

KC-0199-A



Rotational thrust of the propeller is an aspect most single propeller-driven boats share and needs to be compensated for at slow speeds. During rotational thrust, torque is transmitted to the helm and may cause the boat to drift either port or starboard when moving forward at a slow speed. Rotational thrust usually goes unnoticed at high speeds. While moving forward at a slow speed, constant helm corrections are usually necessary to maintain a straight course.

Twin-engine and dual-prop boats usually compensate for rotational thrust of the propellers by using one counterrotating drive with a counterrotating propeller, and one standard clockwise-rotating drive and propeller to reduce the effects of steering torque at all boat speeds.

SHIFTING

The following information is a basic guideline only and may not apply to the specific shift control. See the *Engine Operator's Manual* or control manufacturer's information for the shift control operation, adjustment and maintenance.

- Most side-mounted throttle and shift controls have a neutral detent lock that must be released before shifting from NEUTRAL.
- Always use a brisk and decisive movement when shifting into or out of gear.
- Always pause in NEUTRAL before shifting from FORWARD to REVERSE, or REVERSE to FORWARD. Most throttle and shift controls have a detent position for NEUTRAL, FORWARD and REVERSE engagement positions. These detent positions are important; when shifting into and out of gear, always pause in these positions.
- Never shift into REVERSE while your boat is in FORWARD gear when traveling at any speed above idle.
- Always keep the shift control clean and clear of obstructions.

STOPPING

Reverse thrust is commonly used to slow and stop a boat. The amount of reverse thrust needed to stop will vary due to boat design, load and speed.

 **WARNING** *Control Hazard: Always reduce engine speed to idle and pause in NEUTRAL before shifting from FORWARD to REVERSE or REVERSE to FORWARD. Abrupt stopping and steering loss can occur if the propulsion unit is shifted quickly from FORWARD to REVERSE or REVERSE to FORWARD. Never shift into REVERSE at planing or high forward speeds.*



A boat does not have brakes. Controlling the boat to a stop and while stopped are important skills that must be learned. Reverse thrust is commonly used to slow and stop a boat. The continued momentum of a boat will vary according to the boat design, load and speed. You must also consider and learn to compensate for the effects of wind and current. Stopping in wind or water currents is difficult and requires skill to be able to anticipate and compensate for these effects.

- To stop or slow forward motion, always gradually return the throttle(s) to the slow IDLE position, pause and shift into NEUTRAL, then pause and shift into REVERSE.

**WARNING**

Control Hazard: Gradually return the throttle(s) to the slow IDLE position. Failure to do so can cause loss of boat control and engine propulsion system damage.

- If the boat has been driven for a long period of time at high speed, allow the engine a two- to three-minute cool-down period at low idle in NEUTRAL.
- Turn the ignition key to the OFF position.

NOTICE

Never pull the lanyard from the engine emergency stop switch for normal shutdown. Doing so may impair your ability to restart the engine quickly.

- Avoid collisions; at high speeds the boat will require more time and distance to stop or slow.
- The proper use of trim tabs and outdrive trim angle is important when slowing to a stop.
- If you are new to boating or before your first outing of the season, practice slowing and stopping in open water. Seek on-water training if needed.

ACCELERATING AND RUNNING UNDERWAY

You must understand the boat's equipment and controls in order to drive and control the boat in a forward direction at all speeds and in all conditions. Learning to drive and control the boat can be challenging; take this matter seriously and spend plenty of time practicing.

The phrase "on plane" is commonly used when referring to the running angle of a boat in forward motion. When a boat is "on plane," its hull is usually running level or almost level with the water's surface, which is considered level. The level "plane" of the water's surface is the most efficient angle to run in. This basically means that the boat is running on top of the water and not plowing through it.



Factors to consider when accelerating a boat forward and running at the most efficient planing angle are:

- Boat design
- Hull type and condition
- Boat load and distribution of weight
- Engine capability and condition
- Propeller type, size and condition
- Outdrive and boat power trim equipment and condition

Because all boats are different and vary in design, purpose and load, planing angles and characteristics will vary among all boats. Become familiar with the boat's characteristics and obtain qualified assistance.

The following guidelines provide a basic understanding of forward acceleration and operating on plane while underway:

- Always look in front of and around you before proceeding. Avoid collisions before accelerating; be aware and stay clear of people and obstacles in the water.
- Always advise all passengers on board of your intention to accelerate and get underway.
- Stow and fasten all loose gear.
- Make sure the engine emergency stop switch lanyard is connected to the operator.
- If equipped, adjust the boat trim tabs up or to a neutral position with the hull.
- If equipped, adjust the engine power trim to the full-in position.
- Shift from NEUTRAL into FORWARD detent idle position.
- Adjust steering to the direction of travel.
- Using a controlled and constant motion, move the throttle control forward.

**WARNING**

Control Hazard: When accelerating forward, the bow can rise and restrict visibility. Never remove your hand from the steering wheel. The rotational thrust of the propeller under rapid acceleration can create high steering torque and rapidly change the direction of steering, causing loss of control.

- As the boat begins to move, the bow will rise and the boat will tend to plow through the water. As acceleration increases, the boat will begin to plane or level out within a few seconds. If it will not plane to a near-level position and has sufficient horsepower, slowly reduce the throttle back to the FORWARD detent idle position. Recheck the load distribution and trim equipment position to determine the cause.



- Once the boat is on plane, the steering torque will diminish; however, never remove your hands from the helm while underway. While running at a planed position, you will notice greater throttle response and steering control as you continue to accelerate or achieve the most comfortable and safe speed for the conditions. You can achieve better performance, control and running efficiency using the engine's power trim and the boat's trim tabs, if equipped.
- Be aware of the wake you create and anticipate the effect it will have on others. During acceleration, deceleration and at speeds other than on plane, a heavy wake is usually created. You are responsible for the boat's wake and any damage or injury it causes.
- Obey no-wake areas and speed-controlled areas.
- Stay clear of or at a safe distance from other boats.
- Avoid collisions; at high speeds the boat will require more time and distance to stop or slow.

CHECKS AFTER OPERATION

- Check gauges frequently for signs of abnormal conditions.
- Check that controls operate smoothly.
- Check for excessive vibration.

POWER TRIM

The following information is a basic guideline only and may not apply to your specific power trim unit. See the *Engine Operator's Manual* for information on your power trim operation, adjustment and maintenance.

The engine's power trim allows you to raise and lower the lower drive unit and propeller to adjust the planing and running angle of the boat while underway.

Boat trim adjustment while underway greatly affects boat performance and efficiency. During normal operation while underway at speed, trim the boat to the best possible position to reduce the wetted surface of the hull. With less boat in the water, both speed and fuel economy increase. Adjust systems with manual trim adjustment for best overall operation for the load and conditions. Engines with power trim allow for continuous adjustment for best results.

Adjust the power trim by using a switch at the helm area, MFD, or on the throttle control. Trim gauges are available in most applications to provide a visual gauge-to-trim position. Most gauges indicate trim position between UP (out, away from the transom) and DOWN (in, closer to the transom).

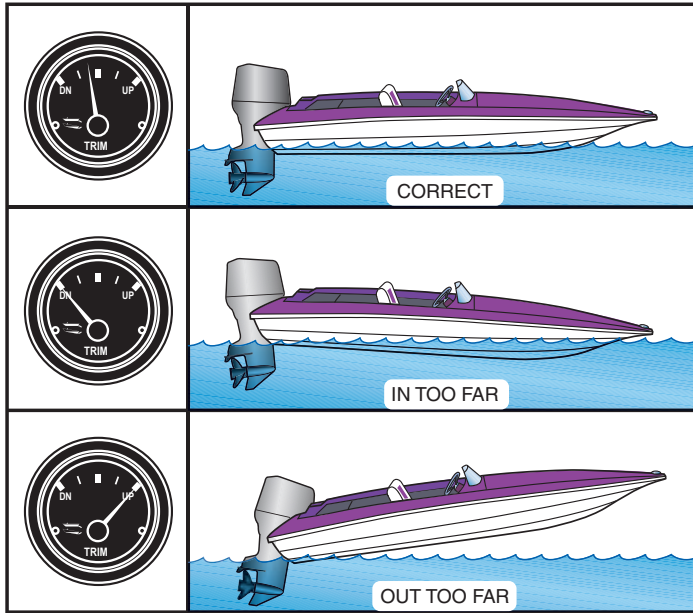

KC-0126C-A

General effects of power trim underway:

Trim in too far (closer to the transom):

- Speed decreases.
- Fuel economy decreases.
- Boat may handle and steer poorly.
- Boat will have difficulty achieving a proper running, planing position.

Trim out too far (away from the transom):

- Steering torque increases.
- Speed decreases.
- Fuel economy decreases.
- Boat may handle and steer poorly.
- Boat will bounce or porpoise.
- Engine RPM increases.
- Propeller may ventilate as it nears the surface of the water and slip excessively as it pulls air from the surface. This will cause engine RPM to rapidly rise.
- Boat will have difficulty getting on plane from an idle position.

**WARNING**

Control Hazard: Do not trim the engine out too far or you may lose control of the boat. If you lose control of the boat, pull back on the throttle and trim in at the same time.

See the *Operating the Boat* section of this manual for more details.

General power trim operation guidelines:

- When getting on plane from an idle position, start with the trim full in. As the throttle position increases, the boat speed will increase and drive the bow up. As acceleration proceeds, the bow will start to come down. When the bow starts to fall and the boat begins to plane, slowly start to trim out.
- Trimming out while underway generally causes the boat to rise up and plane. The boat begins accelerating without adjusting the throttle as less of the boat is dragging in the water. Trimming up causes the engine RPM to increase. It is very important to watch the engine tachometer to keep it at or near full throttle operating range and not to exceed the engine's wide-open throttle operation range. See the *Engine Operator's Manual* for the engine's wide-open throttle operation range.
- To find the optimum trim position while underway, run the boat at a stable planed angle with the least possible amount of the hull in the water. The boat reaches optimum trim position when it is not porpoising or plowing excess water.

High-speed operation on smooth water provides stability, but you must maintain control by using quick reactions and adjustments. Know your limits and stay within them. Keep one hand on the steering wheel and the other on the throttle controls at all times.

**WARNING**

Control Hazard: If you lose control of the boat, pull back on the throttle and trim in at the same time.

Constant adjustments are necessary for rapidly changing conditions. Small inputs of throttle and steering are exaggerated at high speeds. Depending on the speed, keep watch well ahead so that you have enough time to react.

If the boat has trim tabs, you can achieve further boat trim adjustment by using the trim tabs in conjunction with the engine power trim equipment.



TRIM AND TILT

The following information is a basic guideline only and may not apply to your specific power tilt unit. See the *Engine Operator's Manual* for information on your power tilt operation, adjustment and maintenance.

The engine's power tilt generally operates in conjunction with the power trim system, which is commonly called power trim and tilt. This system allows you to raise and lower the lower drive unit and propeller to adjust trim (the planing and running angle of the boat while underway) and tilt (used to position the lower drive unit up beyond the power trim range used for trailering, launching or beaching). Never use power tilt while the engine is running.

TRIM / TILT SWITCH

The power trim/tilt switch controls power ON/OFF to the engine's power trim/tilt electric hydraulic pump. This switch is usually a three-position switch, with OFF in the center. If engine is equipped with power trim and tilt, this system allows you to raise and lower the lower drive unit and propeller to adjust trim (the planing, and running angle of the boat while underway).

The tilt feature positions the lower drive unit up beyond the power trim range and is used for trailering, launching or beaching. Never use power tilt when the engine is running.

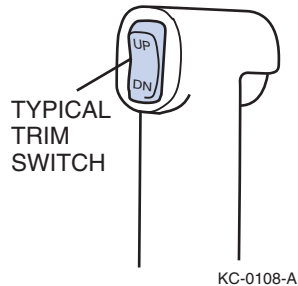

DOCKING

Practice leaving and approaching the dock to become familiar with the procedures.

Helpful guidelines when departing from the dock:

- Make sure you have sufficient space to maneuver the boat away from the dock, other boats and any other obstacles that may hinder your departure.
- Always allow sufficient clearance to the stern for the engine to clear any obstructions.
- Be aware of other boat traffic, wind and water conditions before departing.
- Make sure the engine is started and you have boat movement under control before casting off any mooring lines.
- Always proceed slowly when departing from a dock.

**Helpful guidelines when docking:**

- Make sure you have sufficient space to maneuver your boat around the dock, other boats and any other obstacles that may hinder your approach.
- Be aware of other boat traffic, wind and water conditions on your approach.
- Approach from a direction against the wind or current.
- When possible, approach slowly from a 45-degree angle and then steer parallel to the dock.
- Have fenders, dock lines and assistance ready.
- If your boat has limited visibility from the helm, handheld communicators can be helpful.

**WARNING**

Personal Injury Hazard: Never use your hand, arm or any other part of your body to attempt to keep the boat from hitting the dock. The boat could push against the dock, causing severe injury.

- If possible, throw a mooring line to a person on the dock and have that person secure the bow. With the bow secure, swing the stern in with the engine or pull it in using a boat hook or the stern line.
- Tie off the bow and then the stern.
- Use bow and stern dock lines, as well as spring lines, for additional security.
- Use fenders to protect the boat from damage.
- Never attach a dock line to a point or part of the boat that is not designed to withstand the stress and the weight of the boat.
- If planning on docking the boat for a long period of time, use chafing protectors on the lines to protect the boat's finish.
- Leave some slack in the lines to allow for wave movement or tidal action if applicable.

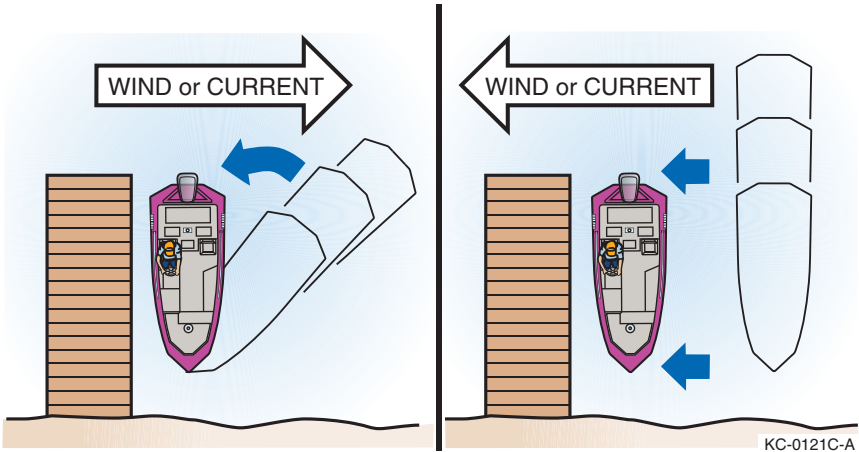

MOORING

Because mooring configurations vary, consult with other experienced boaters or the boat dealer for recommendations on properly mooring the boat. Always moor the boat securely to prevent personal injury or property damage.

Helpful guidelines when mooring:

- Each mooring line must be of the appropriate strength, material and type to safely secure your boat when moored.
- Each mooring line must be longer than the length of the boat.
- Use bow and stern mooring lines, as well as spring lines, for additional security.
- Use fenders to protect the boat from damage.
- When possible, tie up with the bow facing into the wind or current.
- Never attach a mooring line to a point or part of your boat that is not designed to withstand the stress and the weight of the boat.
- Only use the bow eye, stern eyes and other cleats or attachment points that have been approved for mooring. Designated strong points should be used whenever possible.
- If you plan on mooring the boat for a long period of time, use chafing protectors on lines to protect the boat's finish.
- Leave some slack in the lines to allow for wave movement or tidal action if applicable.



ANCHORS AND ANCHORING

Anchors are available for various applications and come in many sizes, types and shapes. Boat weight and size are primary factors in choosing an anchor. When selecting an anchor, consult other qualified boaters familiar with the waters or the boat dealer.

Anchor line is constructed from various materials and is available in many diameters and types; larger craft use chain instead of line. The anchor rode for recreational boats consists of the anchor line connected to a length of chain attached to the anchor. Consult with the boat dealer for a recommendation on appropriate lines for the boat anchor and application.

For most applications, anchor line length should be at least six to seven times longer than the depth of the water in which you are anchoring. Always have plenty of additional anchor line on board. If anchoring in tidal waters, consider a rode chain about the length of the boat and increase the total anchor line length to ten times the depth of the water at low tide.

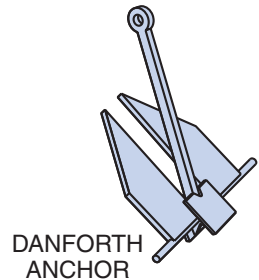

KC-0042-A

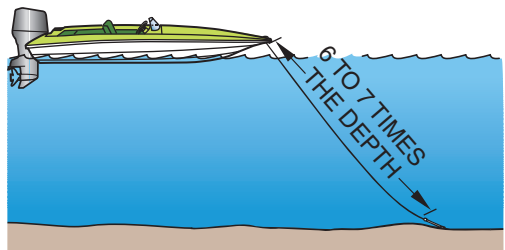

KC-0146C-A



WARNING

Sinking Hazard: In waters with strong currents, always anchor from the bow and do not add an anchor at the stern. A small amount of current will make a boat unsteady. A strong current can pull a boat anchored by the stern under the water and keep it there.

Helpful guidelines when anchoring:

- Make sure the anchor line is tied to the anchor. Tie the other end of the line to the forward cleat or bow eye.
- Head the boat into the wind or current over the spot where you want to lower the anchor.
- Stop the boat before lowering the anchor.
- Scan the shoreline for signs of underwater cables or pipes and avoid these areas.
- Slowly lower the anchor until it hits bottom.



- Allow the boat to back away, keeping tension on the line.
- Release at least six to seven times as much line as the depth of the water.
- Secure the anchor line to a designated strong point, typically the bow eye or dedicated anchor bit.
- Firmly pull on the line to make sure the anchor is holding.
- Occasionally check your position against the shoreline. If the anchor is dragging and the boat is drifting, reset the anchor.

Helpful guidelines when weighing (pulling in) the anchor:

- Start the engine(s).
- If necessary, move forward until enough tension is off the anchor line to allow for retrieval of the anchor. Avoid running over the anchor line; retrieve the line as you approach the anchor.
- Once the anchor line is straight up and down, lift the anchor from the bottom.
- If the anchor is stuck, attach the anchor line to the bow cleat so it is tight. The up-and-down motion of the bow from wave action may loosen the anchor from the bottom. If the anchor remains stuck, let out a few more feet of line and attach it to the bow cleat. While keeping tension on the line, slowly maneuver your boat around the anchor to help loosen it. Avoid running over the anchor line.
- Always stow and secure the anchor and line before departing.



LINES AND KNOTS

Mooring, anchor and other nautical lines are constructed from many different types of materials, and are available in many diameters and styles. Consult with your local marine supply store for a recommendation of appropriate lines for the boat and application. Commonly used mooring lines are constructed of a high-quality synthetic material in a double-braided configuration and usually have eye splices on at least one end.

Learn and become familiar with tying and using knots. Knowing how to use knots and lines properly can prevent personal injury and property damage.

Practice tying lines to docks, cleats and anchors, and connecting two lines together. Consult other qualified boaters or the boat dealer, or visit the local bookstore, library or the Internet for information on the proper use of nautical lines and knots. The following illustrations represent a few examples of securing mooring lines.

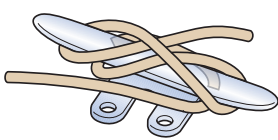

Cleating an open line

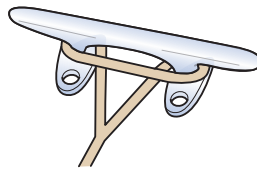

Cleating an eye-spliced line

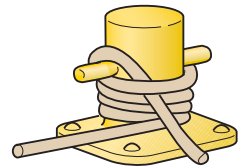

Securing to a dock bitt

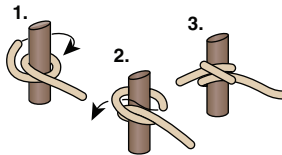

Securing load line
(clove hitch)

A "double half hitch" should always accompany a "clove hitch" on the load line.

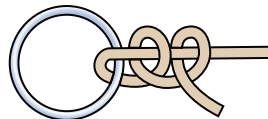

Securing load line
(double half hitch)

KCB-0010



SECTION

7

OPERATING THE BOAT

This Page Intentionally Left Blank

Section 8

TRAILERING AND LAUNCHING

Before using the trailer, review *Safety in Section 2*.

LEGAL CONSIDERATIONS

The following information is intended as a basic guideline only. See the *Trailer Operator's Manual* for information on operation, adjustments and maintenance.

Before using the trailer, contact your state's Department of Motor Vehicles (and that of other states through which you may be traveling) for information on trailering regulations. Trailer regulations vary widely from state to state, and it is your responsibility to be in compliance with all regulations when trailering the boat.

Regulations include, but are not limited to, trailer registration, licensing, width, height, length, lights, safety chains, tie-downs, hitch type, weight capacity, brakes, spare wheels, vehicle mirrors and gross vehicle weight.

TRAILER CLASSIFICATION

Trailers are separated into four classes based on the Gross Vehicle Weight Rating (GVWR):

TRAILER CLASS	GVWR
Class One	under 2000 lb (907 kg)
Class Two	over 2000 lb (907 kg) and under 3500 lb (1588 kg)
Class Three	over 3500 lb (1588 kg) and under 5000 lb (2268 kg)
Class Four	over 5000 lb (2268 kg)

TRAILER TYPE

Trailers are designed for many applications and can vary in style. To prevent damage to the boat and/or personal injury, always use the appropriate trailer for proper support of the boat. Contact the dealer for more information.

TRAILER GROSS VEHICLE WEIGHT RATING

All trailers must display a Gross Vehicle Weight Rating (GVWR) decal, which shows the load-carrying capacity plus the weight of the trailer. The total weight of the boat (fully loaded with fuel, batteries, water, etc.), engine, gear and trailer must never exceed the GVWR.

TOWING VEHICLE

The towing vehicle must be able to safely pull the full trailer and boat load. Never pull a trailer load that exceeds the vehicle's towing capacity; you risk losing control of the trailer and/or vehicle. Before trailering, always check the *Vehicle Operator's Manual* for maximum towing/trailering load specifications and maximum gross vehicle weight specifications that include the fully loaded trailer.

VEHICLE TOWING HITCH

The towing vehicle must be able to safely pull the full trailer and boat load. The vehicle must have a towing hitch that is capable of safely handling the trailering load and tongue weight of the trailer.

Hitches are designed for many applications and can vary in style. Use professional assistance when selecting the correct hitch and hitch ball for the towing application.

 **WARNING** *Control Hazard: A vehicle hitch that is underrated or improperly installed can lead to loss of control of the trailer and/or vehicle. Never use a hitch that is not rated to pull the maximum weight of the trailering load or that is not rated for the maximum tongue weight that the trailering load applies.*

Hitches are divided into classes that specify the trailer's gross trailer weight and maximum tongue weight for each class.

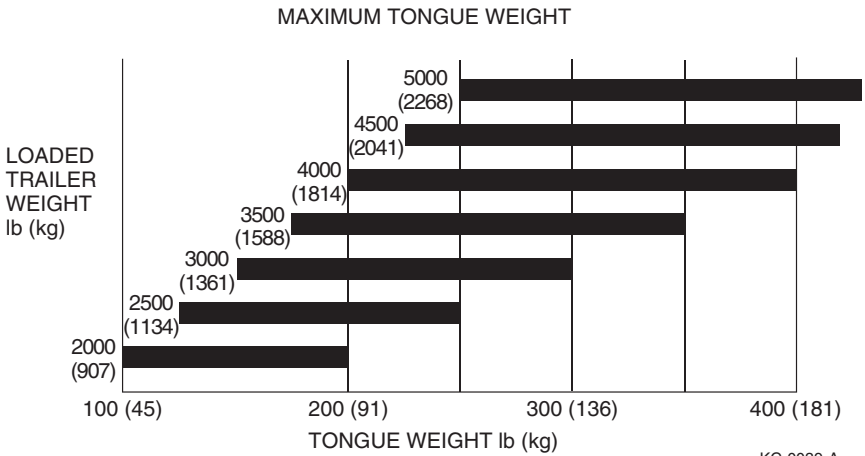

HITCH BALL AND TRAILER COUPLER

Most boat trailers have a coupler that connects to a hitch ball attached to the towing vehicle's hitch. The trailer hitch coupler must always match the size of the hitch ball. The correct hitch ball diameter for the coupler is usually marked on the trailer coupler.

⚠️ WARNING **Control Hazard:** *Never use a hitch ball size or rating that does not match the trailer coupler specifications. Using an improper size or rated hitch ball can lead to loss of control of the trailer and/or vehicle.*

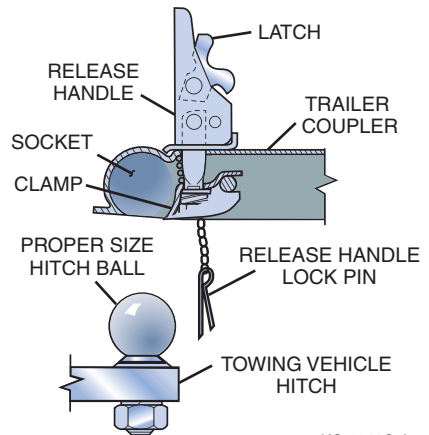



Trailer hitch balls are sized and rated for use based on the trailer GVWR:

TRAILER CLASS	GVWR	HITCH BALL DIAMETER SIZE
Class One	under 2000 lb (907 kg)	1-7/8 in. diameter size
Class Two	over 2000 lb (907 kg) and under 3500 lb (1588 kg)	2 in. diameter size
Class Three	over 3500 lb (1588 kg) and under 5000 lb (2268 kg)	2 in. diameter size
Class Four	over 5000 lb (2268 kg)	2-5/16 in. diameter size

SAFETY CHAINS

The boat trailer's safety chains prevent the trailer from completely detaching from the towing vehicle when underway. Connect the chains to the vehicle's hitch or frame and crisscross the chains under the trailer tongue to prevent the tongue from dropping to the road if the trailer separates from the hitch ball. Rig the chains as tight as possible with enough slack to permit full-free turning. Safety chains must be rated at the same or greater weight capacity as the trailer's GVWR.

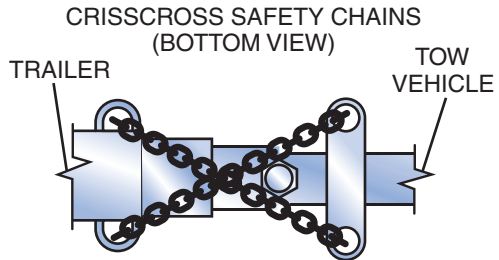

KC-0045C-A

Never allow the chains to drag on the ground when trailering.

Attach the chains properly and securely between the towing vehicle and trailer before trailering.



TRAILER BRAKES

In some states, any trailer with a GVWR of 1500 lb (680 kg) or more is required to have trailer brakes.

Check with your state and local authorities for more information.

The three basic types of trailer brakes are electric, hydraulic surge and air-actuated. If the trailer is equipped with brakes, see the *Trailer Operator's Manual* for more information on operation, adjustments and maintenance.

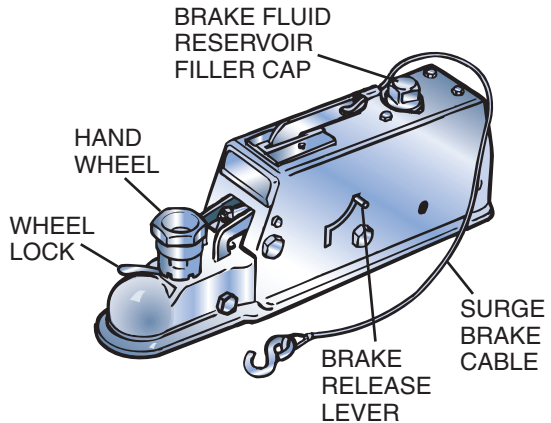

KC-0044C-B

5-PIN WIRING CONNECTOR

Some trailers equipped with surge brakes may utilize a 5-pin wiring connector. These trailers use an electric solenoid valve that allows brake fluid to bypass back to the reservoir while in REVERSE. The solenoid is usually connected to the reverse lights on the tow vehicle to ensure the brakes only bypass in REVERSE. The fifth pin is for deactivating the brakes when backing up, and is required to be connected to the vehicle's power when backing up.



TRAILERING GUIDELINES

ENGINE-TRANSOM SUPPORT BRACKET

The trailer must be equipped with an engine-transom support bracket for each engine. The support must transfer the weight of the engine to the trailer cross-member. Devices that are used between the engine and engine transom bracket do not provide adequate protection. Damage to the transom motor pod, engine and trailer from shock loads is not covered by the boat, engine or trailer warranties.

Follow these guidelines when trailering:

- Before driving, make sure the vehicle maintenance and trailer maintenance are current. This is very important because towing puts additional stress on the tow vehicle.
- Make sure the wheel lug nuts/bolts on the tow vehicle and trailer are tightened to the correct torque.
- Be sure the hitch, coupler, draw bar and other equipment that connect the trailer and the tow vehicle are properly secured and adjusted.
- Make sure all running lights, brake lights, turn signals and hazard lights are working.
- Verify that the brakes on the tow vehicle and trailer are operating correctly.
- Maintain a safe speed as regulated by the trailering laws of the state where you are traveling.
- Check the trailer and vehicle brakes for proper operation and fluid level prior to departure.
- Check the trailer for damage prior to departure.
- Make sure the hitch ball and trailer coupler are the same size and bolts and nuts are tightly secured.
- The coupler must be completely over the ball, and the latching mechanism must be locked down.
- Make sure the safety chains are properly crisscrossed and connected. They should not touch the road but should have enough slack to make turns. If the ball were to break, the trailer would follow in a straight line and prevent the coupler from dragging on the road. Make sure the trailer emergency brake cable or chain is also installed to the tow vehicle frame.

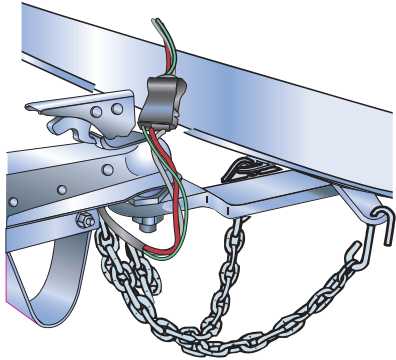

KC-0046C-A



- Ensure the breakaway system lanyard is connected to the tow vehicle and not to the safety chains or ball mount.

NOTE — Make sure the towing vehicle and trailer are in compliance with all state and local laws. Contact your state motor vehicle bureau for laws governing the towing of trailers.

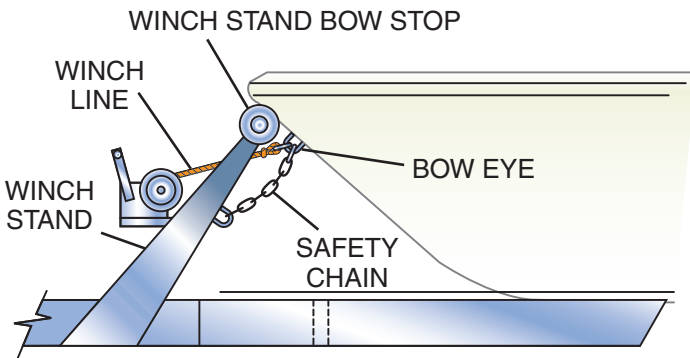

KC-0047C-A

- Once the trailer is secured to the vehicle hitch, stow the trailer jack or lift so that it will not hit the ground.
- Check and correct tire pressure on the tow vehicle and trailer, including the spare tire. Under-inflated tires heat up rapidly and may cause tire damage or failure. The proper tire pressure is listed on the trailer certification plate.
- Check trailer wheel bearings before each trip.
- Secure the stern of the boat to the trailer from the stern eyes.
- Fasten the bow of the boat to the trailer with the bow winch line connected to the bow eye and bow safety chains.
- If travel conditions require, use an additional tie-down strap across the rear of your boat from side to side to further secure the stern.
- Check all strapping material for wear.
- Check that the wiring is properly connected. It should not touch the road but should be loose enough to make turns without disconnecting or damaging the wires.
- Too much or too little tongue weight makes steering difficult and causes the tow vehicle to sway. Put approximately 5% to 10% of boat and trailer weight on the tongue.
- Drive with the vehicle and trailer running lights on.



TRAILERING AND LAUNCHING

- Check load distribution to make sure the tow vehicle and trailer are properly balanced front to back and side to side.
- Check that all items are securely fastened on and in the trailer.
- Be sure the trailer jack, tongue support and any attached stabilizers are raised and locked in place.
- Check side-view mirrors and rearview mirrors for good visibility.
- Check routes and restrictions on bridges and tunnels.
- Keep wheel chocks and jack stands on hand.
- Side curtains, backdrop, aft curtains, convertible tops and detachable windshields are not designed to stay on boats at highway speeds. Before towing, take down the convertible top, side curtains, back cover and detachable windshield, if equipped.
- Remove any covers that are not designed to stay on boats at highway speeds.
- Carry a spare tire and wheel for both the trailer and the towing vehicle, along with tools to change them.
- See the *Engine Operator's Manual* for engine-related trailering information. Continuous road shocks may fatigue the boat's steering system.
- Tie outboard motors in place so they will not tilt or turn from road shock.
- On extended trips, carry spare wheel bearings, seals and races.
- While traveling, check the wheel hubs every time you stop. If the hub feels abnormally hot, inspect the bearing before continuing your trip.
- Carry a fire extinguisher in the vehicle.
- Turn carefully while towing a trailer; additional space and distance are needed.
- Drive slowly over railroad tracks or rough roads.
- While trailering the boat from lake to lake, boaters may unknowingly introduce a foreign aquatic species from one lake to the next. Thoroughly clean the boat below the waterline, remove all weeds and algae and drain the bilge and livewells before launching it in a new body of water.

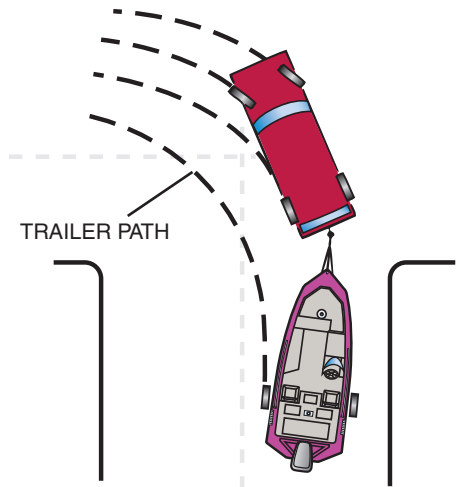

KC-0288C-A



BACKING UP

If you have never towed a trailer before, take time to practice and become comfortable with backing up the boat and trailer. Situations can arise in traffic, or when launching, that will require you to be able to back up the trailer safely.

Follow these guidelines when backing a trailer:

- Back slowly and make small steering adjustments.
- Turn the car wheels in the direction opposite where you want the trailer to go.
- After the trailer begins moving, turn the car to follow it.
- Have a second person assist you with audible and hand signals.

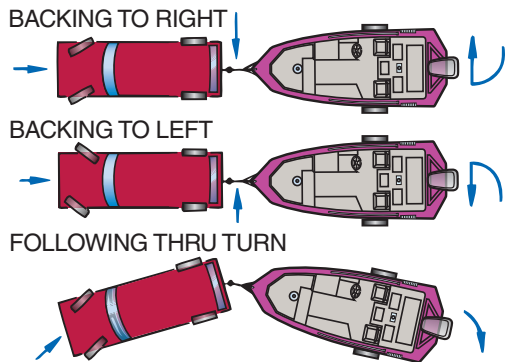

KC-0163C-A

LAUNCHING

Before launching, inspect the launch ramp for any problems that may hinder launching or make launching unsafe. Ramps can be slick and dangerous to drive or walk on, and may have unseen drop-offs beneath the water that would pose a safety hazard. Always be aware of water conditions and the effects of the wind when launching.

Before launching, inspect the boat and trailer for damage. Do not launch if you detect damage or find that the engine or propeller is not in good operating condition. Have any repairs made before launching.

Use courtesy when preparing the boat for launching by preparing away from the ramp on level ground before proceeding to the launch ramp.

When launching the boat on the trailer, have two or more people assist you. Since all launches are different, the following procedures are intended as guidelines only:

- Verify that the vehicle's brakes, including the parking brake, are in proper working order.
- Make sure the trailer is securely fastened to the vehicle.
- Remove the boat cover, if equipped.



TRAILERING AND LAUNCHING

- Check that the bilge drain plug is in place and all other plugs that allow water to leak into the boat are in place.
- Remove all tie-downs from the boat.
- Attach the bow and stern docking lines.
- Attach boat fenders if necessary.
- Disconnect the trailer's light harness from the car.
- If applicable, trim or tilt the engine/outdrive up to avoid damage.
- Make sure the bow winch and strap are securely locked and fastened.
- Make sure the bow winch safety chains, if equipped, are in place.
- Make sure all required documentation and safety equipment are on board.
- Verify that batteries are fully charged and in good condition.
- Check fuel level; add fuel if necessary.
- Always launch with the help of another person.
- Make sure there is no one on the ramp behind the boat.
- Keep the trailer/vehicle combination as straight as possible and at 90 degrees to the shoreline.
- Back slowly down the ramp until the transom of the boat is a few inches in the water; then stop the vehicle.
- Stop the vehicle and shift into PARK (automatic transmission) or REVERSE (manual transmission). Apply the brakes and/or parking brake. If possible, use wheel blocks.
- Position the mooring lines within reach of the dock.
- Disconnect the bow winch strap and safety chains, if equipped, from the bow eye.
- Manually back the boat clear of and off the trailer into the water and secure to the dock using mooring lines.
- Remove any wheel blocks and release the vehicle brakes. Pull the trailer slowly out of the water, and secure and park in a designated area.
- Board the boat.
- Lower the engine/outdrive, if applicable.
- Run the bilge blowers as required, if equipped.
- See the *Engine Operator's Manual* for starting procedures.
- Remove dock lines from the dock and proceed slowly away from the dock.



LOADING GUIDELINES

Follow these guidelines while loading the boat onto the trailer:

- When loading the boat on the trailer, have two or more people assist you.
- Stop, turn off the engine and secure it to the dock with dock lines at a position clear from where the trailer will be in the water.
- If applicable, trim or tilt the engine/outdrive up to avoid damage.
- Verify that the vehicle's brakes, including the parking brake, are in proper working order.
- Disconnect the trailer's light harness from the tow vehicle.
- Make sure the trailer is securely fastened to the vehicle.
- Back the trailer slowly down the ramp until it is positioned so that the boat can be loaded.
- Stop the vehicle and shift into PARK (automatic transmission) or REVERSE (manual transmission). Apply the brakes and/or parking brake. If possible, use wheel blocks.
- Position the mooring lines within reach of the dock.
- Manually position the boat onto the trailer using mooring lines. Make sure it is centered on the supports of the trailer.
- Position the bow eye into the bow stop and connect and secure the bow winch strap and safety chains, if equipped, to the bow eye.
- Secure the mooring lines inside the boat.
- Remove any wheel blocks and release the vehicle brakes. Slowly pull the trailer and boat up the ramp.
- Secure the transom to the trailer.
- Prepare for trailering as necessary.

REPORTING SAFETY DEFECTS

If you believe that your boat trailer has a defect which could cause a crash or could cause injury or death, you should immediately inform the National Highway Traffic Safety Administration (NHTSA) in addition to notifying the trailer manufacturer.

If NHTSA receives similar complaints, it may open an investigation, and if it finds that a safety defect exists in a group of trailers, it may order a recall and remedy campaign. However, NHTSA cannot become involved in individual problems between you, your dealer or the boat manufacturer.

To contact NHTSA, you may call the Vehicle Safety Hotline toll-free at 1-888-327-4236 (TTY: 1-800-424-9153); go to <https://www.nhtsa.gov>; or write to Administrator, NHTSA, 1200 New Jersey Avenue SE, Washington, DC 20590. You can also obtain other information about motor vehicle safety from <https://www.nhtsa.gov>

Section 9

SAFETY LABELS AND LAYOUTS

This section is specific to your G3 boat. The features and their locations on your particular boat may differ from what is shown in the following image(s). Contact your G3 dealer if you have any questions regarding your specific boat.

Your G3 boat is affixed with various hazard and safety decals at the time of manufacture. These decals appear in specific locations on the boat and on equipment where safety is of particular concern. All operators of the boat must read and understand all hazard and safety decals and advise all passengers on the safety concerns and proper safety-related practices. Hazard and safety decals must remain legible. If you suspect a decal is missing or damaged, contact a G3 dealer for immediate replacement.

**ENGINE FAMILY SAFETY LABELS**

SAFETY LABEL	SPORTMAN	BAY	ANGLER AND GUIDE V	PACKAGE JON	LOOSE JON
73409011	x	x	x	x	
73409013	x	x		x	
73409076	x	x	x	x	
73409034	x	x	x	x	x
73409035	x	x	x	x	x
73409043	x	x	x	x	x
73409044			x		
73409047	x	x	x	x	x
73409050			x		
73409051	x	x	x	x	x
73409057	x		x	x	
73409065	x		x		
73409068				x	
73409072	x				

SAFETY LABELS AND LAYOUTS



INDIVIDUAL SAFETY LABELS

– NOTICE –
THIS CONTROL IS
RIGGED TO "PUSH"
TO OPEN THROTTLE

73409011

⚠ WARNING

AVOID SERIOUS INJURY OR DEATH FROM FIRE OR EXPLOSION FROM LEAKING FUEL. CONTENTS CAN BE UNDER PRESSURE. OPEN SLOWLY IN WELL VENTILATED AREA, NO SMOKING OR OPEN FLAMES. CHECK FOR LEAKS AT LEAST ANNUALLY.

PN: 73409076

⚠ WARNING

NO VENTILATION IS PROVIDED. FUEL VAPORS ARE A FIRE AND EXPLOSION HAZARD. TO AVOID INJURY OR DEATH, DO NOT STORE FUEL OR FLAMMABLE LIQUIDS HERE.

73409013

⚠ WARNING

ROTATING PROPELLER MAY CAUSE SERIOUS INJURY OR DEATH.

DO NOT APPROACH OR USE LADDER WHEN ENGINE IS RUNNING.

73409050

⚠ DANGER



Carbon monoxide (CO) can cause brain damage or death.

Engine and generator exhaust contains odorless and colorless carbon monoxide gas.

Carbon monoxide will be around the back of the boat when engines or generators are running.

Move to fresh air if you feel nausea, headache, dizziness, or drowsiness.

73409034

⚠ WARNING



Carbon monoxide (CO) can cause brain damage or death.

Engine and generator exhaust contains odorless and colorless carbon monoxide gas.

Signs of carbon monoxide poisoning include nausea, headache, dizziness, drowsiness, and lack of consciousness.

Get fresh air if anyone shows signs of carbon monoxide poisoning.

See Owner's Manual for information regarding carbon monoxide poisoning.

73409035

 **WARNING**

THE USE OF AN ETHANOL BLENDED FUEL GREATER THAN 10% CAN CAUSE DAMAGE TO FUEL SYSTEM COMPONENTS IN THE BOAT AND ENGINE. THIS INCREASES THE RISK FOR FIRE, WHICH CAN CAUSE SERIOUS INJURY OR DEATH.

73409043

 **WARNING**

AVOID SERIOUS INJURY OR DEATH
SEAT LOCATION NOT INTENDED FOR USE AT HIGHER SPEEDS
DO NOT OCCUPY SEAT WHEN SPEED EXCEEDS 5 MPH.

73409044

 **WARNING**

ROTATING PROPELLER MAY CAUSE SERIOUS INJURY OR DEATH.

SHUT OFF ENGINE WHEN NEAR PERSONS IN THE WATER.

73409047

 **WARNING**

**ROTATING PROPELLER MAY CAUSE
SERIOUS INJURY OR DEATH.**

**DO NOT APPROACH TRANSOM OF BOAT
WHEN ENGINE IS RUNNING.**

73409051

 **WARNING**

Avoid serious injury or death from fire, explosion, or electrical shock.

- This device must be connected to a Ground Fault Circuit Interrupt (GFCI)-protected AC outlet.
- When using an extension cord, connect the AC charger plug before connection to the GFCI-protected AC outlet.
- Make connection in an open atmosphere free of explosive fumes.
- Make connection in a secure manner that will avoid contact with the water.

73409065

SAFETY LABELS AND LAYOUTS

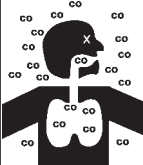

 WARNING	
Rotating propeller may cause serious injury or death. Shut off engine when near persons in the water.	
	<p>Carbon monoxide (CO) can cause brain damage or death.</p> <p>Engine and generator exhaust contains odorless and colorless carbon monoxide gas.</p> <p>Signs of carbon monoxide poisoning include nausea, headache, dizziness, drowsiness, and lack of consciousness.</p> <p>Get fresh air if anyone shows signs of carbon monoxide poisoning.</p> <p>See Owner's Manual for information regarding carbon monoxide poisoning.</p>
BOATER'S CHECKLIST	
For maximum enjoyment and safety, check each of these items. BEFORE YOU START YOUR ENGINE:	
<ul style="list-style-type: none"> ✓ DRAIN PLUG (Securely in place?) ✓ LIVE-SAVING DEVICES (One for every person on board?) ✓ STEERING SYSTEM (Working smoothly and properly?) ✓ FUEL SYSTEM (Adequate fuel? Leaks? Fumes?) ✓ BATTERY (Fully charged? Cable terminal clean and tight?) ✓ ENGINE (in neutral?) ✓ CAPACITY PLATE (Are you overloaded or overpowered?) ✓ WEATHER CONDITIONS (Safe to go out?) ✓ ELECTRICAL EQUIPMENT (Lights, horn, pump, etc?) ✓ EMERGENCY GEAR (Fire extinguisher, bailer, paddle, anchor and line, signaling device, tool kit, etc?) 	

73409057

 WARNING
<p>VISIBILITY FROM THE SEATED POSITION WITH HUNTING BLIND INSTALLED IS LIMITED. OPERATION FROM A STANDING POSITION WITH THE HUNTING FLAPS IN THE DOWN POSITION IS NECESSARY.</p> <p>AVOID SERIOUS INJURY OR DEATH FROM COLLISIONS. MAINTAIN A LOOKOUT AS REQUIRED BY USCG NAVIGATION RULES.</p>

73409068

 WARNING
<p>AVOID SERIOUS INJURY OR DEATH. UNEXPECTED SEAT ROTATION MAY CAUSE EJECTION OF OCCUPANT.</p> <p>LOCK SWIVEL WHEN SPEED EXCEEDS 5 MPH.</p>

73409072



SPORTSMAN TYPICAL HELM LAYOUT

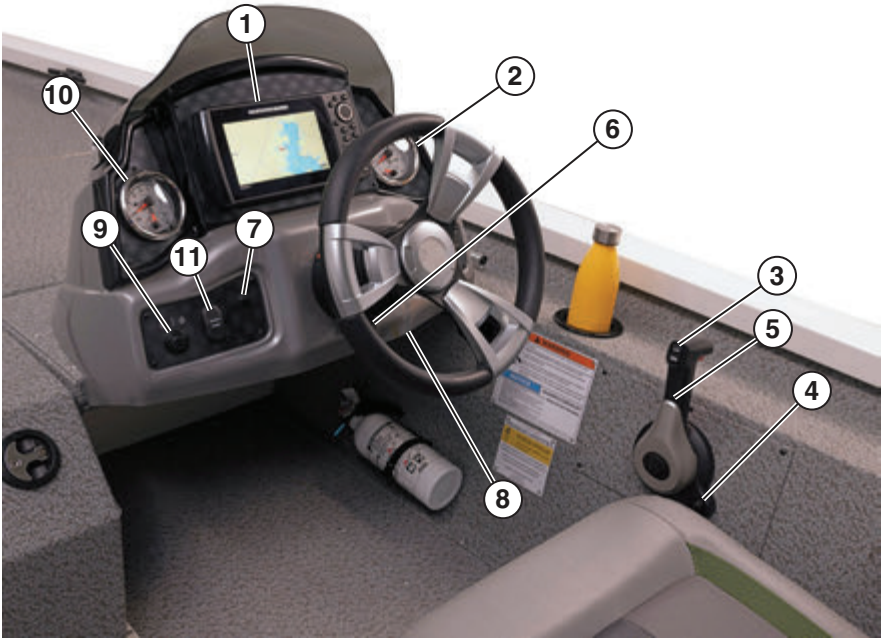

0001_G3



1. Fishfinder/Depthsounder
2. Speedometer/Fuel Combo Gauge
3. Trim Switch
4. Engine Emergency Stop Switch and Lanyard*
5. Throttle
6. Tilt Steering Latch
7. Horn
8. USB Charge Port
9. Ignition Switch
10. Tach/Trim Combo Gauge
11. Master Power Switch

* Attach the engine stop switch cord lanyard to your life jacket. Install the cord clip onto the engine stop switch by pushing the clip groove over the nut beneath the knob. Be sure the cord is not wrapped around the steering wheel or tangled in the controls.



SPORTSMAN TYPICAL DECK LAYOUT

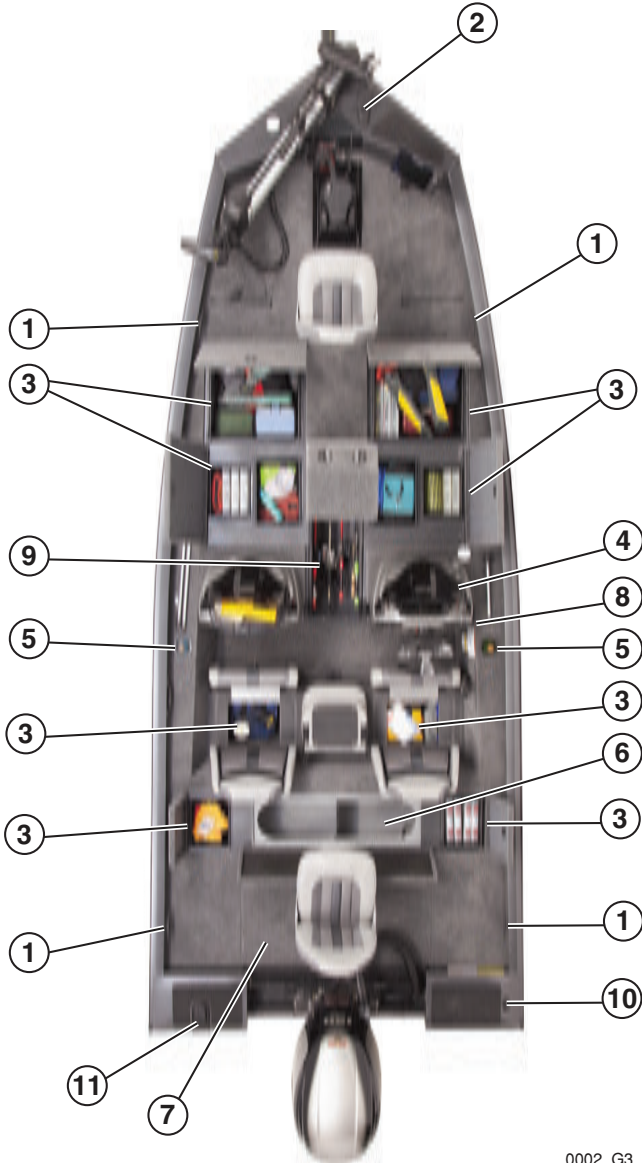

0002_G3

SAFETY LABELS AND LAYOUTS

SECTION

9



1. Cleats
2. Bow Light Receptacle
3. Gear Storage
4. Console
5. Cupholders
6. Livewell
7. Access to Batteries
8. Fire Extinguisher
9. Rod Storage
10. Anchor Light Receptacle
11. Fuel Inlet



BAY TYPICAL HELM LAYOUT

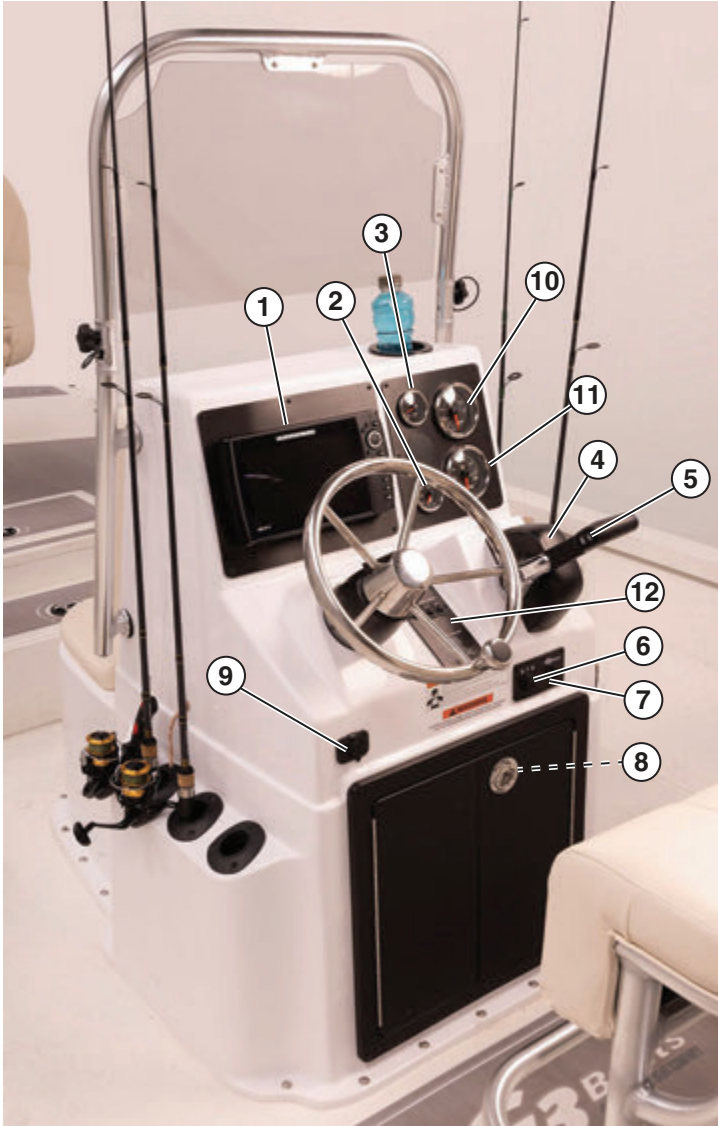

0003_G3



1. Fishfinder/Depthsounder
2. Fuel Level Gauge
3. Trim Gauge
4. Throttle
5. Trim Switch
6. Ignition Switch
7. Engine Emergency Stop Switch and Lanyard*
8. Fuse Panel
9. 12 VDC Accessory Port
10. Speedometer
11. Tachometer
12. Switch Panel – Nav/Anchor Lights, Bilge Pump, Master Power, Horn, Aerators

* Attach the engine stop switch cord lanyard to your life jacket. Install the cord clip onto the engine stop switch by pushing the clip groove over the nut beneath the knob. Be sure the cord is not wrapped around the steering wheel or tangled in the controls.



BAY TYPICAL DECK LAYOUT

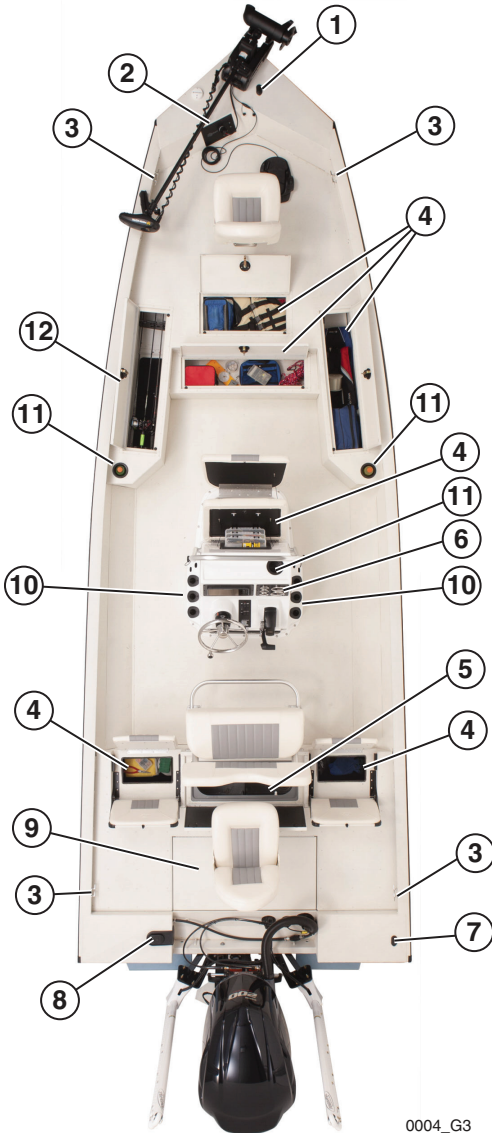

SAFETY LABELS AND LAYOUTS

SECTION

9



1. Bow Light Receptacle
2. Bow Panel
3. Cleats
4. Gear Storage
5. Livewell
6. Console
7. Anchor Light Receptacle
8. Fuel Inlet
9. Access to Batteries and Fuel Tank
10. Rod Holder
11. Cup Holders
12. Rod Locker



ANGLER AND GUIDE V TYPICAL HELM LAYOUT



G3_060



1. Fishfinder/Depthsounder
2. Switches
3. Ignition Switch
4. Phone Holder
5. Throttle
6. Trim Switch
7. Engine Emergency Stop Switch and Lanyard*
8. USB Charge Port
9. Breaker Panel
10. Tilt Steering Latch
11. Fire Extinguisher
12. Stereo Control
13. Trim Gauge
14. Speedometer
15. Voltmeter
16. Tachometer
17. Fuel Level Gauge

* Attach the engine stop switch cord lanyard to your life jacket. Install the cord clip onto the engine stop switch by pushing the clip groove over the nut beneath the knob. Be sure the cord is not wrapped around the steering wheel or tangled in the controls.



ANGLER AND GUIDE V TYPICAL DECK LAYOUT

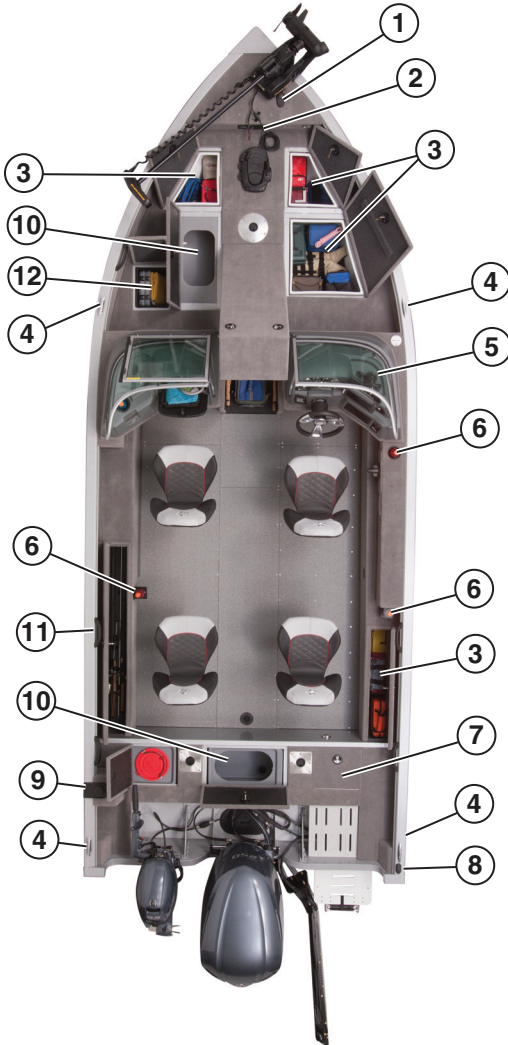

0006_G3



1. Bow Light Receptacle
2. Bow Panel
3. Gear Storage
4. Cleats
5. Deluxe Console
6. Cup Holders
7. Access to Batteries and Fuel Tank
8. Anchor Light Receptacle
9. Fuel Inlet
10. Livewell
11. Rod Holder
12. Tackle Tray Storage



GATOR TOUGH™ DELUXE JON TYPICAL HELM LAYOUT

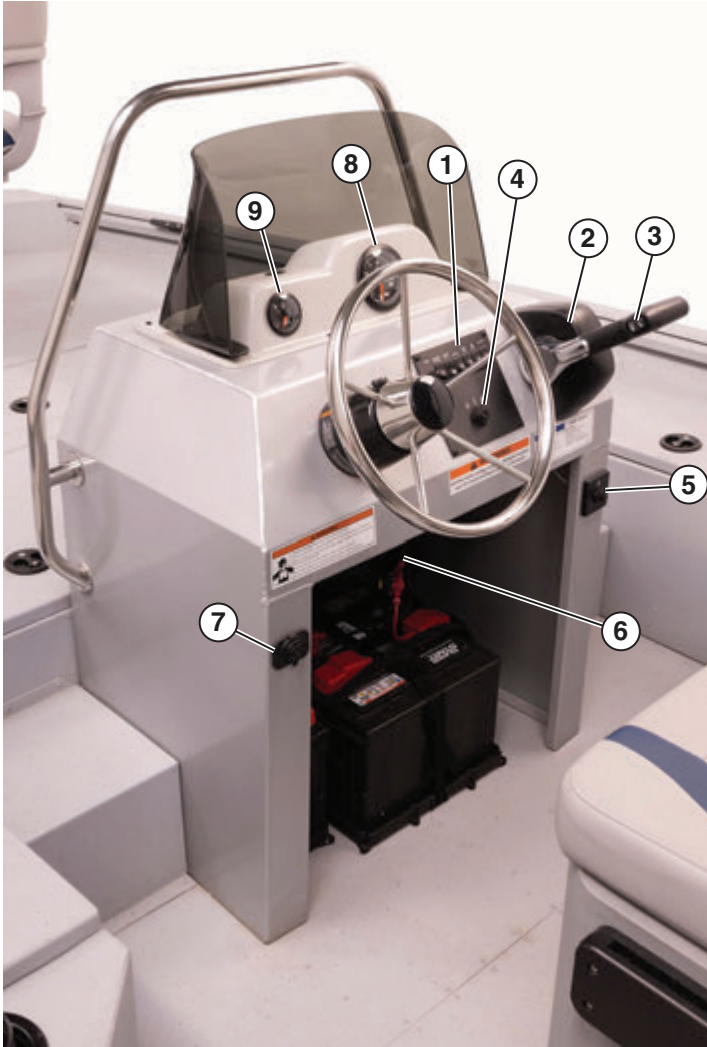



1. Switches
2. Throttle
3. Trim Switch
4. Ignition Switch
5. Engine Emergency Stop Switch and Lanyard*
6. Fuse Panel
7. 12 VDC Accessory Port
8. Tachometer
9. Fuel Level Gauge

* Attach the engine stop switch cord lanyard to your life jacket. Install the cord clip onto the engine stop switch by pushing the clip groove over the nut beneath the knob. Be sure the cord is not wrapped around the steering wheel or tangled in the controls.



GATOR TOUGH™ DELUXE JON TYPICAL DECK LAYOUT

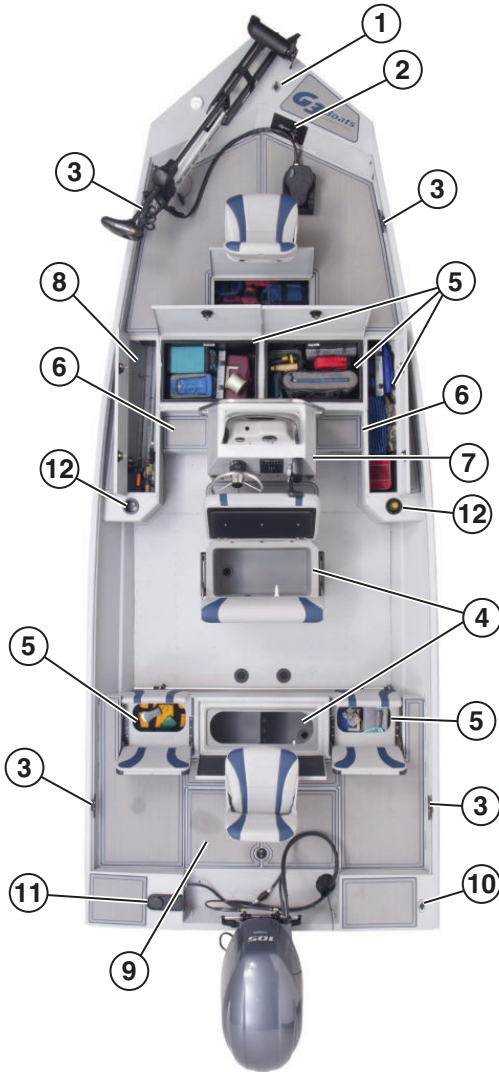

0008_G3



1. Bow Light Receptacle
2. Bow Panel
3. Cleats
4. Livewell
5. Gear Storage
6. Step to Deck
7. Deluxe Console
8. Rod Holder
9. Access to Batteries and Fuel Tank
10. Anchor Light Receptacle
11. Fuel Inlet
12. Cup Holders



SECTION

9

SAFETY LABELS AND LAYOUTS

This Page Intentionally Left Blank

Section 10

CONTROLS, SYSTEMS AND OPTIONS

Before operating any systems within this section, review *Safety in Section 2*.

CONTROLS AND INDICATORS

NEUTRAL START SAFETY SWITCH

The neutral start safety switch provides start-in-gear prevention. The switch controls power to the engine starter circuit of the ignition switch. The engine gear shift control lever must be in the NEUTRAL position to allow the ignition switch to activate the engine starter. This safety device will prevent the boat's engine from starting if the engine is in gear. Most throttle/shift controls have this feature.

SINGLE-LEVER CONTROLS - SINGLE OR TWIN ENGINE

Single-lever controls operate both the gear shift and the throttle for one or two engines with one control lever.

NEUTRAL - The lever is detented in the NEUTRAL position (center of travel) for starting; the neutral safety switch allows starting in this position only. For engine warm-up, a separate lever or button on the control is used to disengage the shift cable and allow the throttle to advance only while the transmission remains in NEUTRAL.

FORWARD - Release the detent lock to allow shifting to the FORWARD position. Moving the lever into the first 15 degrees of travel (toward the bow or up) positions the control in the FORWARD detent IDLE position. Advancing the lever beyond 15 degrees allows throttle increase in FORWARD.

REVERSE - Release the detent lock to allow shifting to the REVERSE position. Moving the lever into the first 15 degrees of travel (toward the stern or down) positions the control in the REVERSE detent idle position. Advancing the lever beyond 15 degrees allows throttle increase in REVERSE.

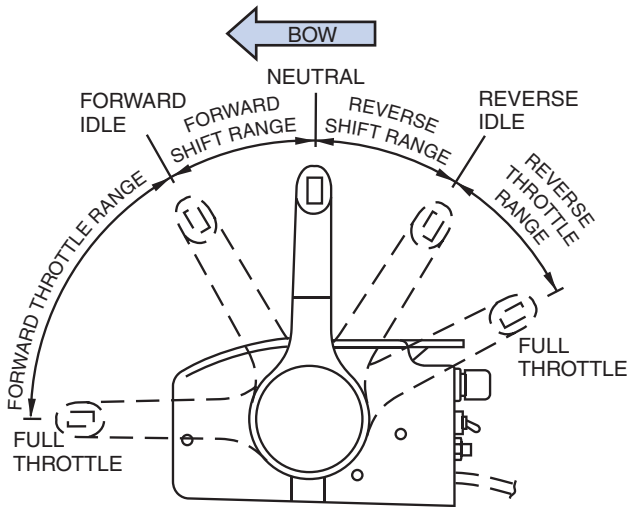

KC-0092-A

CONTROL OPERATION GUIDELINES

⚠ WARNING *Control Hazard: Improperly maintained controls are hazardous and may cause sudden loss of control. Make sure all shift/throttle hardware and cables are regularly inspected and maintained. Improper maintenance may result in a loss of control.*

- Side mount throttle and shift controls have a neutral detent locking lever that must be released before shifting from NEUTRAL.
- Always use a brisk and decisive movement when shifting into or out of gear.
- Always pause in NEUTRAL before shifting from FORWARD to REVERSE, or REVERSE to FORWARD. Most throttle and shift controls have a detent position for NEUTRAL, FORWARD and REVERSE engagement positions. Engine damage may occur if you rapidly shift into gear without pausing in these detent positions or allowing the engine RPM to lower into the approved shifting range.
- When traveling at high speed, never shift into REVERSE while your boat is in FORWARD gear.
- Always keep the shift control clean and clear of obstructions.

**NOTICE**

Most shift and throttle controls are equipped with a safety switch for start-in-gear prevention. Place the control in the NEUTRAL position before you attempt to start the engine.

- Never attempt to shift when the engine is not running.

GAUGES/INSTRUMENTS

NOTE — Types of gauges and switches vary by model. Not all models have all of the following items. Some of the following items are optional and cost extra. G3 reserves the right to change specifications without notice.

Tachometer

The tachometer registers engine speed in revolutions per minute (RPM). Refer to the *Outboard Motor Operator's Manual* for the correct operating range of the engine.

Speedometer

The speedometer indicates the speed of the boat in miles per hour. Be sure the speedometer pilot tube is clean and free from debris. Also make sure the speedometer tube is not pinched and allows for proper operation of the gauge.

Fuel Gauge

The fuel gauge registers the fuel level (not gallons) in the gas tank. In some cases, because of the shape and size of the tank, when the fuel gauge registers 1/2 of a tank of fuel, there may be as much as 3/4 of a tank of fuel. Due to the various conditions affecting the way a boat floats, the gauge may register differently when the boat is on the trailer, at rest or on plane.

Engine Warning Light

To assist in detecting engine emergency conditions while the boat is running at speed and while engine and wind noises are high, a red engine symbol on the tachometer is provided. This symbol will indicate a warning and is integrated into the engine. The symbol provides a visual warning in addition to the engine's audible warning. The symbol illuminates continuously when the engine is hotter than normal running temperature. The symbol will blink in conjunction with the engine audible alarm test when you first turn on the ignition. Refer to the *Outboard Motor Operator's Manual* for additional information.



SECTION
10 **CONTROLS, SYSTEMS AND OPTIONS**

Trim Gauge (if equipped)

The trim gauge indicates the bow position of the boat in the water and helps you change the angle of the outboard motor.

Sonar Fishfinder and Depthsounder (if equipped)

Refer to the *Fishfinder and Depthsounder Operator's Manual*.

Voltmeter (if equipped)

The voltmeter indicates voltage to the batteries from the charging system.

SWITCHES

Power Switch

This switch activates the gauges, most of the other switches and most boat systems. The power switch is the main supply switch to all boat systems except the trolling motor system. No systems will work when this is set to the OFF position.

Bilge Switch

The bilge switch activates the bilge pump, which eliminates excess water in the bilge. To prevent damage to the pump, be sure the switch is kept in the OFF position unless the pump is in use.

Courtesy Light Switch

The courtesy light switch activates interior lights for nighttime illumination.

Navigation Lights Switch

The navigation lights switch activates the bow and stern lights in the RUN position and just the stern light in the ANC position. The lights should be in the RUN position while underway and in the ANC position when anchored or tied in open water or channels. The ANC light is not required if tied up at a dock or beached.

NOTE — Operate the boat between sunset and sunrise using the navigation lights. Navigation lights are legally required to indicate direction and right-of-way at night.

Accessory Switches

Accessory switches are installed for use and convenience when installing optional equipment.

Horn Switch

The horn switch activates the horn. It is momentary and will return to the OFF position when released.



BOAT SYSTEMS

STEERING SYSTEM

Under certain power trim positions of the outboard motor, there can be a noticeable pull on the steering wheel. This is often referred to as “steering torque.” The position of the outboard motor’s trim tab affects the amount of steering torque. Refer to the *Outboard Motor Operator’s Manual* to adjust the trim tab. The operator should always keep a firm, continuous grip on the steering wheel in all circumstances.

The owner/operator must inspect the steering system frequently.

- For cable steering, check for smooth, free, full-range operation and ensure steering components are not worn or loose.
- For hydraulic steering, check the fluid level periodically to determine the correct level.



WARNING

Control Hazard: Failure to comply with steering maintenance checks may result in loss of steering control, which may cause an accident, injury or death.

Your G3 dealer should investigate any steering system irregularities immediately. DO NOT continue to operate the boat if the steering system is malfunctioning.

Hydraulic Steering System (if equipped)

Maintenance of the hydraulic steering system varies with usage and climate. Have a qualified marine mechanic inspect it at least twice a year or at the first sign the steering system is not operating normally.

To check the oil level, remove the steering fluid fill cap. The oil level should be within 1/2 inch of the bottom of the filler hole. Refer to the manufacturer’s literature for more information on maintenance.

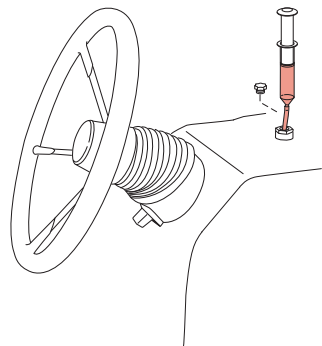

9343-020

Tilt Steering Latch

Pull the latch toward you to adjust the steering wheel angle. The steering wheel has five positions and locks into a detent.



Throttle

A single-lever control operates both the gear shift and the throttle for the engine with one control lever.

NOTICE

DO NOT shift the engine into gear if it is operating above 900 RPM. Only shift the engine into gear at the recommended idle speed.

ELECTRICAL SYSTEM

G3 boats have sophisticated electrical systems to provide service and function to their owner. Batteries located in the aft rigging compartment directly in front of the engine supply the power. Red positive (+) leads and black negative (-) leads with ring terminals for connecting to batteries are located in this compartment.

Depending on the model, there may be two heavy-gauge wires for the trolling motor system to connect to the trolling motor batteries. There may be two lighter-gauge wires for the boat supply or “accessory” harness to connect to the engine cranking battery. Some system models are built with trolling motor batteries and wiring under the front deck.

Circuit Breakers/Fuses

The main power supply at the battery, automatic bilge pump switches and trolling motor systems is protected from current overloads by circuit breakers or fuse holders at their power supply or at the battery in the positive (+) lead.



WARNING

Fire Hazard: Never reset a circuit breaker that has been automatically tripped or replace a fuse that has blown without first identifying and correcting the cause of the problem. Failure to correct the cause may result in a fire hazard.

Circuit Breakers (need example for each model)

Some main switch panels and trolling motor wiring are equipped with circuit breakers. Labels on the circuit breaker buttons indicate which circuit they protect. If the protected circuit has a current overload, the breaker will trip and discontinue power. Determine and fix the cause of the overload before resetting the circuit breaker. Reset the circuit breaker by pressing its button.

Fuses



WARNING

Fire/Explosion Hazard: DO NOT exceed the recommended fuse sizes or bypass the fuse safeguard. Always install the proper (type and rating) fuses whenever replacing or changing fuses.

Bus-type fuses, located under the console, protect some electrical systems.



Battery Connections

Refer to the *Outboard Motor Operator's Manual* for battery requirements.

Maintain the battery or batteries following the battery manufacturer's recommendations.

Disconnect all battery cables before servicing the battery or the outboards and make sure metal objects do not touch the battery posts.



WARNING

Explosion Hazard:

- ***Keep the battery connections clean, tight and insulated to prevent shorting or arcing and causing a possible explosion. Install protective covers and check the connections often to make sure they are clean and tight.***
- ***DO NOT charge your batteries in the boat if your boat is not equipped with an onboard charging system.***
- ***Make sure all accessories and outboards are in the OFF position before making any battery connections.***

Keep the outboard motor battery separate from your electric outboard battery or batteries. If you operate your electric outboard from the outboard motor battery, it will discharge the battery and your battery may not have the required amperage to crank the outboard motor.

SECTION
10 CONTROLS, SYSTEMS AND OPTIONS

The illustration shows a typical 12-, 24-, and 36-volt connection.

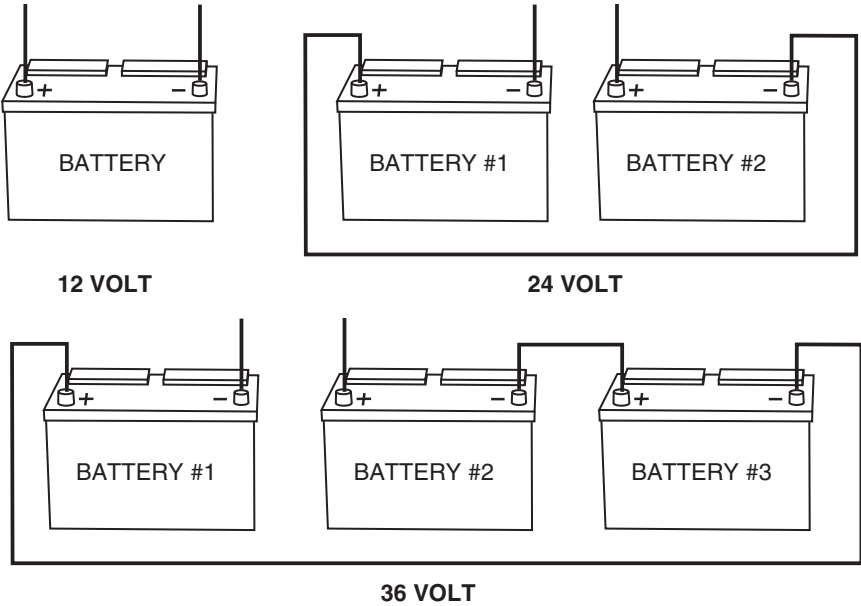

9343-016

NOTE —

- Connect the 12-volt accessories to the outboard motor's battery or to the number 2 battery if two batteries are used for the electric outboard. If they are connected to the number 1 battery, galvanic corrosion can occur and damage the electric outboard.
- If the boat is equipped with a 24-volt electric outboard, interference can occur if you connect the accessories to the same batteries. Interference can also occur if the transducer wire is strapped or run next to the electric outboard's battery cable. Make sure the transducer wire is routed away from the cable and other wires.
- If the electric outboard is connected to the battery using a receptacle, make sure all the connections are tight. If you operate the electric outboard with loose connections, damage to the electric outboard can result.
- Never check the connections by running either of the outboards out of the water.



BATTERY CHARGING SYSTEM (IF EQUIPPED)

The battery charging system allows you to charge the batteries without removing the batteries from the boat. Refer to the manufacturer's literature for operating instructions.

Make sure all accessories and outboards are in the OFF position when connecting to the power source and charging the batteries.



WARNING

Fire/Explosion Hazard: Do not charge the batteries in the boat unless the boat is equipped with an onboard charging system.

BILGE SYSTEM

A bilge pump is designed to remove excess that may accumulate in the bilge area. Make sure the bilge pump is not blocked with debris and is in proper working order. Check the pump screen occasionally and monitor the stream from the bilge pump outlet. If you recognize a weak stream at the bilge outlet, this may indicate a blocked pump screen or a poor electrical contact. If you recognize no stream, this could indicate a blown fuse or a pump malfunction.

Never operate a dry bilge pump or damage to the pump will occur.

SECTION
10 CONTROLS, SYSTEMS AND OPTIONS

The following illustration shows a typical bilge pump system with an automatic float switch.

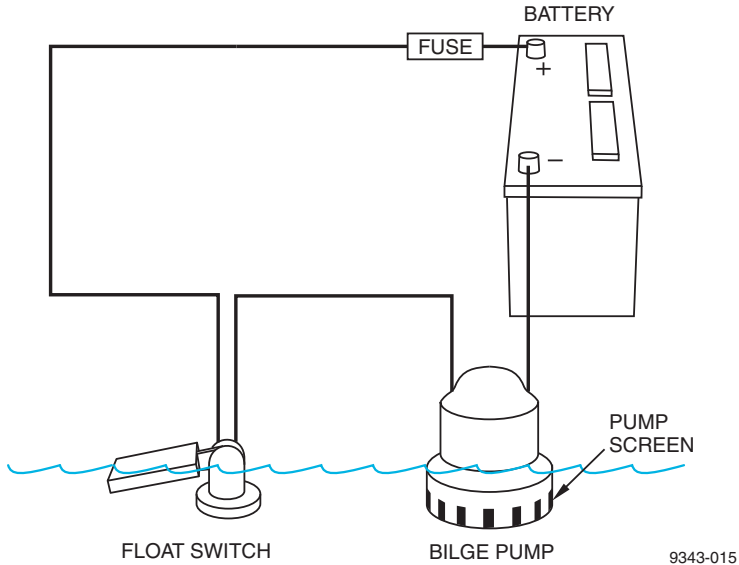

FUEL SYSTEM

The G3 boat is equipped with an internal fuel system meeting current federal requirements.

Thoroughly inspect and repair the fuel system, if necessary, before operating the boat. Do not operate the boat knowing you have a fuel system problem.

If you suspect the boat has a fuel system problem, contact your G3 dealer.

WARNING *Fire/Explosion Hazard: Leaking fuel is a fire and explosion hazard. Inspect system regularly. Examine fuel system for leaks or corrosion at least annually. Failure to inspect the fuel system could allow fuel leakage to go undetected, resulting in a fire or explosion.*

Sometimes boats are equipped with a capped second fuel-delivery connector that supplies fuel to a “kicker motor.”



LIVEWELL SYSTEMS

Livewell System with Recirculation

Take time to familiarize yourself with the controls for the livewell system.

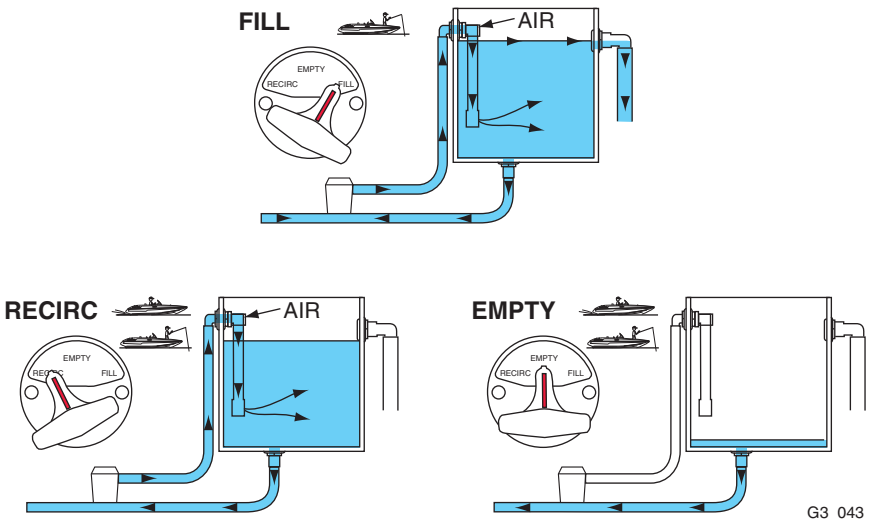

G3_043

The Livewell Drain Control ACTUATOR positions the Flow-Rite remote drain control valve in the FILL, RECIRCULATE and EMPTY positions.

The electrical AERATOR switches control the power to the aerator pump. These switches can be placed in the MANUAL position for continuous duty or the AUTO position for intermittent use.

NOTE — When in the AUTO position, an automatic timing feature is enabled that allows the pump to run in a one-minute-on/two-minutes-off cycle. This cycle will continue until the timer is moved to another position other than AUTO.

Filling: Before filling, close the livewell drain by placing the drain control valve cable actuator in the FILL position. Fill the livewell by turning on the fill pump while the boat is off plane. The fill pump can be operated any time the boat is off plane and should, at a minimum, be operated periodically during the day to top off and freshen the livewell water.

SECTION 10 CONTROLS, SYSTEMS AND OPTIONS

Recirculation: When the boat is off plane, place the drain control valve in the RECIRCULATE position to provide aeration for the livewell. The recirculate pump can be left on during on-plane runs for continuous circulation duty.

Emptying: To empty the livewell, turn off the pumps and place the drain control valve in the EMPTY position. This will allow the livewell to drain by gravity while the boat is on the trailer or on plane. If draining while on plane, move the drain to the FILL position once the livewell is empty and before coming off plane to prevent water from entering the drain. Draining while off plane will only allow the water level to drain to the outside water level.

Pump-Out Feature: If the boat is equipped with the pump-out/aerator combo, pump out the livewell while the boat is on or off plane or on the trailer. Pull the head of the pump-out aerator to the PUMP-OUT position and place the drain control valve in the RECIRCULATE position. This feature can be used to lower the livewell water level to facilitate fish removal for tournament weigh-ins and for filling weigh-in bags. It can also be used to simply empty the livewell before a tournament blast-off when the drain control valve has been inadvertently left in the OPEN position during boat launching.

Rinse the livewell and baitwell (if equipped) with fresh, clean water and remove any debris from the pick-up and drain screens. Allow the livewell to air-dry after each use. The pick-up screens are located at the bottom of the transom and the drain screens are located in the livewell or baitwell.

NOTE — Always rinse the livewell with fresh, clean water. Check and clean the pick-up screens and drain screens before each use to optimize the system's performance and longevity.

Livewell System Without Recirculation

Take time to familiarize yourself with the controls for the livewell system.

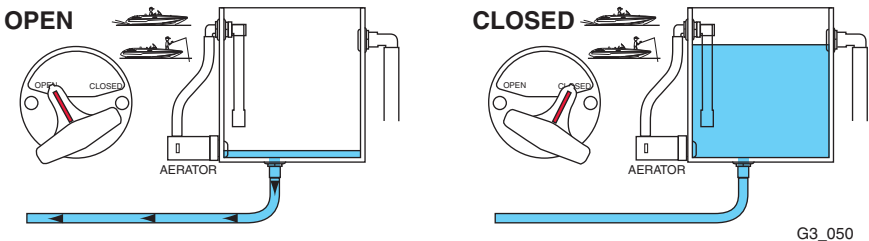

The electrical AERATOR switches control the power to the aerator pump.



These switches can be placed in the MANUAL position for continuous duty or the AUTO position for intermittent use.

Use the selector switch to drain or maintain a full livewell.

OPEN – On/Off Plane: Actuator in the OPEN position drains the livewell after the aerator is turned off.

CLOSED – On/Off Plane: Actuator in CLOSED position seals the livewell when it is full and prevents water from entering the livewell if it is empty.

NOTE — When in the AUTO position, an automatic timing feature is enabled that allows the pump to run in a one-minute-on/two-minutes-off cycle. This cycle will continue until the timer is moved to another position other than AUTO.

On livewells equipped with a drain plug:

1. Insert the drain plug.
2. Turn the livewell aerator pump on to MANUAL until full.
3. Once full, turn the aerator pump to AUTO.
4. To drain, remove the drain plug and turn off the aerator.

Rinse the livewell and baitwell (if equipped) with fresh, clean water and remove any debris from the pick-up and drain screens. Allow the livewell to air-dry after each use. The pick-up screens are located at the bottom of the transom and the drain screens are located in the livewell or baitwell.

NOTE — Always rinse the livewell with fresh, clean water. Check and clean the pick-up screens and drain screens before each use to optimize the system's performance and longevity.

FEATURES AND OPTIONAL EQUIPMENT

Not all optional equipment for your G3 boat is covered in this manual.

Manufacturers of the optional equipment on your boat provide information on the options' safety, use and maintenance. Read and understand this information to maximize the benefits of this optional equipment. Contact your G3 dealer for any information or explanation.



LOCKING SWIVEL FISHING SEATS

Press the locking handle down to release the lock. This will allow you to rotate the seat on the post. The locking handle must be in the locked position when the boat speed exceeds 5 mph.

WARNING *Ejection Hazard: Always lock the handle before the boat speed exceeds 5 mph. Failure to do so may result in people becoming ejected from the rotating seat.*

Seat Swivel Lock Lever



G3_037A

LOCKING SWIVEL FISHING SEATS WITH FRICTION CONTROL

Press the locking handle down to release the lock. This will allow you to rotate the seat on the post. Twist the friction control knob to control friction on the post. The locking handle must be in the locked position and the friction control knob must be tightened when the boat speed exceeds 5 mph.

WARNING *Ejection Hazard: Always lock the handle and tighten the friction control knob before the boat speed exceeds 5 mph. Failure to do so may result in people becoming ejected from the rotating seat.*

Friction Control Knob



G3_037



SWIVEL/SLIDER SEATS

Press the release lever to raise the seat back into position.

1. Friction Knob - Twist this handle to increase the friction on the post.
2. Forward/Back Lever - This lever adjusts the seat fore and aft.
3. Rotation Lever - This lever allows you to rotate on the post.

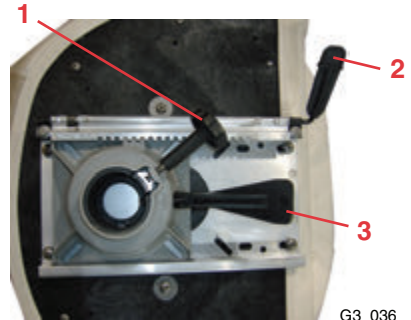

G3_036



WARNING

Ejection Hazard:

Always lock the swivel before the boat speed exceeds 5 mph. Failure to do so may result in people becoming ejected from the rotating seat.

BOW AND STERN LIGHT

The G3 boat is equipped with a bow and stern light. The navigation lights switch must be activated for this feature to work.

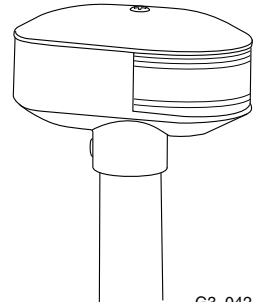

G3_042



TRANSOM SAVER

The transom saver is designed to protect the boat, outboard motor and trailer.

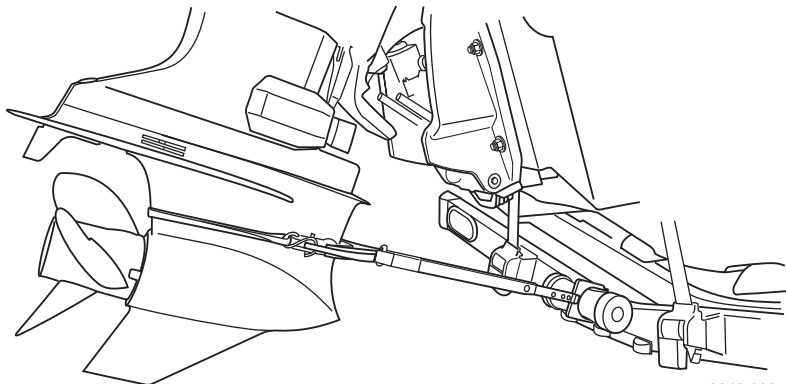

9343-022

NOTICE

Avoid damage to the outboard lower unit. The transom saver must be properly fitted to the trailer roller and secured to the outboard lower unit. The transom saver is designed to work on boats that have an outboard motor as well as power tilt and trim. The boat must be tied down to the trailer during use of the transom saver.

ELECTRIC TROLLING MOTOR

The electric trolling motor will have its own *Operator's Manual*. Refer to this manual for proper use and care of the electric trolling motor.

POLE ANCHOR

The boat may be equipped with a powered pole anchor that quickly holds the boat in position in shallow water without using a traditional anchor.

12 VDC ACCESSORY PORT

The 12-volt DC accessory port allows you to conveniently connect an accessory to your electrical system. The accessory port is equipped with a 10-amp fuse.

NOTICE

Do not connect an accessory that exceeds the 10-amp fuse rating.



USB CHARGING PORT

The G3 boat may be equipped with a USB port for charging tablets, smartphones and other electrical devices.

AM/FM STEREO

The G3 boat may be equipped with an AM/FM stereo. Refer to the *Stereo Operator's Manual* for more information.

BATTERY CHARGER

The G3 boat may be equipped with an onboard battery charger.

WALK-THROUGH WINDSHIELD

The G3 boat may be equipped with a walk-through windshield that provides comfort for people in the cockpit area.

Always have the windshield closed and locked when the boat is moving.

Never use abrasives or solvents to clean the windshield. Use only mild soap and water or a quality glass cleaner.



WARNING

Personal Injury Hazard: To avoid injury, the window must be secured in the locked position when the boat is in motion. Use both window locks.

BOARDING LADDER

The G3 boat may be equipped with a boarding ladder for easier boarding into the boat from the water. Make sure the boarding ladder is in the stowed position after it is used. Always make sure no one is near the engine before you start it. Never use a damaged ladder.



WARNING

Sever Hazard: Be careful when using the boarding ladder and exercise caution when you are near the outboard. Do not board the ladder while the engine is running. The outboard and propeller can have sharp edges. Always make sure no one is in the area behind the boat and that the ladder is in the stowed position before starting the outboard.



TURBOSWING TOW BAR

Some G3 boats are equipped with a TurboSwing tow bar which allows you to attach a watersports tow harness to the boat without interfering with the operation of the outboard engines.



0009_G3

CANOPY TOP (OPTION)

The canopy top provides comfort to people in the cockpit area and helps block them from the sun and the elements.

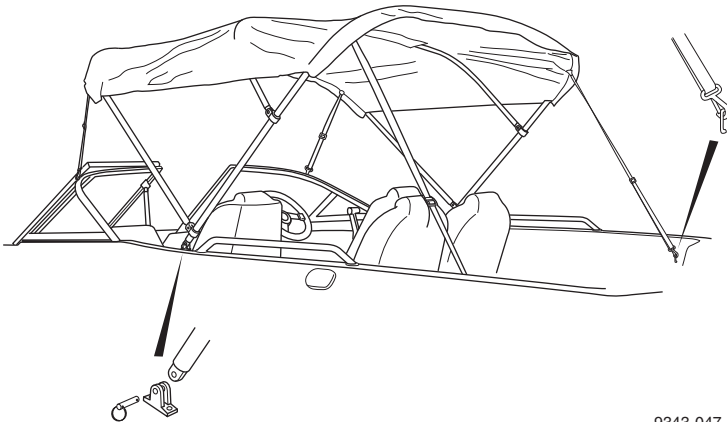

9343-047



Make sure the canopy top is in a secured position before getting the boat underway.

- Never stow the canopy wet or damp. Allow it to air-dry before stowing.
- Never use abrasives or solvents to clean the canopy. Use only mild soap and warm (not hot) water to clean it. Apply a high-quality protectant to extend its life.
- Never trailer your boat with the canopy top raised.

To raise the canopy:

1. Attach the supports into their mounts.
2. Remove the canopy boot.
3. Attach the bow straps to their mounting cleats.
4. Attach the stern straps to their mounting cleats.
5. Adjust the canopy's tension by adjusting the strap buckles.

Make sure the cockpit is well-ventilated when the canopy top is raised.



WARNING

Exhaust Hazard: Exhaust fumes from engines contain carbon monoxide. A boat with its canvas raised is more likely to collect exhaust fumes. Avoid brain damage or death from carbon monoxide. Keep the cockpit well-ventilated. Signs of exposure to carbon monoxide include nausea, dizziness and drowsiness.



WARNING

Control Hazard: Do not operate at high speeds with the top up. Death or injury could result.

FUEL FILTER

Use a cartridge-replaceable-type fuel filter to remove contaminants from the fuel.



SAFETY SYSTEMS

ENGINE EMERGENCY STOP SWITCH AND LANYARD

The engine emergency stop switch controls the engine ignition ON/OFF. This safety device shuts the engine off immediately and prevents the boat from becoming a runaway if the operator is accidentally thrown from the seat or away from the helm.

Whenever the boat's engine is on, physically secure one end of the emergency engine stop switch lanyard to the emergency stop switch and the other to the boat operator. Some optional systems use a wireless FOB attached to the operator. If the operator is thrown from the seat or moves too far from the helm, the lanyard will disconnect from the switch, activating the switch to turn off the engine.

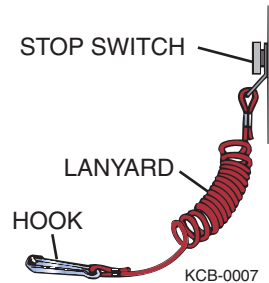

WARNING

Control Hazard: Never remove or modify the engine emergency stop switch and/or lanyard.

- **Always check the switch for proper operation. With the engine running, pull the lanyard. If the engine does not stop, have the switch repaired before continuing to operate the boat. Never operate the boat if the engine emergency stop switch does not work.**
- **Attach the engine stop switch cord lanyard to a secure place on your clothing, your arm or leg while operating.**
- **Avoid accidentally pulling the cord lanyard during normal operation. Loss of engine power means loss of most steering control. Also, without engine power, the boat could slow rapidly. This could cause people and objects in the boat to be thrown forward.**
- **DO NOT attach the cord lanyard to clothing that could tear loose. DO NOT route the cord lanyard where it could become entangled, preventing it from functioning.**

Section 11

GENERAL CARE AND MAINTENANCE

The boat may feature a variety of specialized systems and components. The following basic and typical information may not apply to your specific application. This section may not cover all systems or components on the boat. See the *Engine Operator's Manual* or the equipment manufacturer's information for maintenance procedures.

Maintenance procedures may require special knowledge and equipment. Always consult the boat dealer for assistance in performing service, maintenance or modifications to the boat.

Neglect of maintenance and unauthorized service work is not recommended and may void your warranty. Refer to the *Engine and Equipment Manufacturer's* maintenance schedules and requirements, and keep a detailed log of the procedures and dates completed. Always consult the boat dealer for assistance with periodic maintenance.

Before performing any general care and maintenance procedures within this section, review *Safety in Section 2*.

REPAIRS AND MODIFICATIONS

The G3 boat is designed for safety in the harsh marine environment and thoroughly tested and certified for compliance with applicable safety standards. Because of the possibility of interference with the design of the boat, owner installation of additional equipment or modification of factory equipment is not recommended.

In addition, DO NOT attempt to make repairs unless you are certified to do so, have the necessary authorized repair information and use approved marine replacement parts.

Your G3 dealer is qualified to make such repairs, additions or modifications to the boat that will not compromise safety, design integrity or warranty coverage.



SAFETY EQUIPMENT

Periodically check the safety equipment for damage, general condition and operation when applicable. Always replace safety equipment that is in question or in need of repair:

- Fire extinguisher
- Life jackets
- Visual distress signaling devices
- Audible signaling devices
- Navigational lights
- Emergency radios or Emergency Position Indicating Radio Beacon (EPIRB) or Personal Locator Beacon (PLB)
- First aid kit
- Batteries in electronic devices
- Ditch kit
- Life raft

LIFE JACKETS

Maintaining life jackets is important to extending their life. Proper cleaning/sanitation will help rid life jackets of sunscreen, mold and mildew that may break down materials over time. When cleaning, be sure to inspect life jackets for wear and tear that might require repair or replacement. Life jackets are often neglected until they are needed. Consult the life jacket's owner's manual or website for more information.

Use and Storage

Life jackets that are wet, dirty, or stored in humid conditions can deteriorate quickly. Sunscreen products and body oils can accelerate deterioration. The following tips will help to extend the life of life jackets:

- After use, air-dry jackets out of direct sunlight and away from tree sap. If on the boat, choose a well-ventilated space.
- If you can't air-dry outside, place the jackets on hangers, space at least 6 inches apart, and ventilate with an oscillating fan.
- If dirty (sand or stains) or used in salt water, rinse jackets with plenty of fresh water.
- If stained from sunscreen, foods, or other sources, clean as soon as possible.
- Clean life jackets at least annually.



Do Not:

- Use chlorine bleach directly on a jacket, as it can break down fabrics and interior foam.
- Clean jackets with industrial cleaning agents or something like gasoline, paint thinner or acetone. They can dissolve the foam that makes the device functional and weaken the exterior fabric.
- Machine-wash, dry-clean or use strong detergents or degreasers.
- Dry jackets with a direct heat source or clothes dryer.
- Bend life jackets or place heavy objects on top of them, as this can cause crushing and damage performance.

Cleaning Life Jackets:

Clean the life jackets annually at the end of the season. To clean:

- Fill a bucket with cool water and about two tablespoons of mild liquid laundry detergent.
- Lay a tarp on the ground and place the life jackets, with all straps and hardware unfastened, on the tarp.
- Treat stains with a laundry pre-wash stain remover, work it in with a soft brush and allow it to work for 5 minutes.
- Scrub all surfaces of the jacket using the detergent solution and a soft brush.
- If the jacket has mold or mildew, move it to an outside area and brush away any visible spores before wetting the fabric. Scrub as suggested but add 1/4 cup of oxygen-based bleach to the cleaning solution to help remove dark stains.
- Rinse well using plenty of clean water.
- Hang the jacket to drip-dry out of direct sunlight.
- Place the jackets on hangers, space at least 6 inches apart, and ventilate with an oscillating fan until completely dry.
- Store life jackets in a dry, cool, dark place.



SECTION
11 GENERAL CARE AND MAINTENANCE

BOATING EQUIPMENT

Periodically check the general equipment on board for damage, general condition and operation when applicable. Always replace equipment that is in question or in need of repair.

- Anchors and anchor lines
- Boat hook
- Dock fenders
- Foul weather gear/clothing
- Mooring lines
- Oars/paddles
- Tool kit
- Tow line

CORROSION PROTECTION

GALVANIC CORROSION

Galvanic corrosion (electrolysis) is the deterioration of metals from the effects of electrolytic action. When two dissimilar metals are immersed in a conductive fluid such as salt water, an electric current is produced, much like a battery. As current flows between the two metals, the softer, or sacrificial, metal deteriorates.

If you operate in salt, polluted or brackish waters, the boat should be equipped with a transom-mounted sacrificial anode to prevent corrosion damage to other metal parts of your boat that are in contact with the water. The anodes are self-sacrificing and are slowly eroded by electrolytic action. These anodes are important and require periodic inspection for deterioration. Replace the anode when it is less than 50% of its original size.

Most propulsion units and transom-mounted accessories are equipped with one or more anodes that require periodic inspection. See the propulsion/accessory *Operator's Manual* for maintenance procedures.

NOTICE

Do not paint or coat sacrificial anodes or cathodes with any substance. Once covered, they do not provide protection from galvanic corrosion. Replace anodes if they have deteriorated 50% or more.

Optional, electronic cathode systems are designed to reduce the effects of electrolysis by emitting an electrical low-current charge into the water near the metal components' neutralizing electrolytic action.



SALTWATER CORROSION

Any boat exposed to salt water can be affected by the salt. However, to minimize the effects of salt water on boats, consider the following preparation and maintenance. Corrosion prevention is key and proper maintenance will mitigate the damaging effects of salt water.

If you plan to use your boat in salt water, all portions of the boat that will be submerged should be painted with an approved anti-fouling paint. This service is provided by your dealer or by someone recommended by your dealer. There is an extra charge for this service.

If you trailer your boat and use it in salt water, be sure that the bottom of the boat has a barrier between it and the bunks. If anti-fouling paint is not used, salt water trapped in the trailer bunks can cause corrosion at the point where the trailer bunk meets the hull.

In some cases you may need to have sacrificial anodes added to your boat to prevent electrolysis. Ask your dealer whether he recommends adding anodes. There is an extra charge for this service.

Some boats and/or propulsion systems may be designated as “Saltwater Series.” This designates that additional design and/or materials are used to make them more resistant to the effects of salt water, but not “saltwater proof.” The following maintenance also applies to saltwater series products.

Maintenance

Removing saltwater deposits from the boat as quickly as possible is the key to keeping saltwater corrosion in check.

- Rinse the boat hull and deck with fresh water and wash immediately after using the boat in salt water. Allow the boat to dry before covering it with the mooring or seat covers.
- Flushing the engine cooling system is recommended when the engine has been used in salt, polluted or brackish waters. Flush the entire engine cooling system with fresh water for at least 5 minutes after use in these waters. See the *Engine Operator's Manual* for the flushing procedure. Consult the boat dealer for suitable flushing equipment.
- You should repair paint chips and scratches when you start to notice bare metal showing. Do not paint any sacrificial anodes; rather, remove any oxidation with sandpaper.
- Cover your boat WHEN DRY with seat covers or a mooring cover to keep salt and weather off of your boat. Since most saltwater areas are very humid it is imperative that the boat be dry before it is covered. If you cover it wet you will see mildew develop.

SECTION 11 GENERAL CARE AND MAINTENANCE

- A yearly inspection for corrosion or deterioration of the electrical connections is recommended.
- If the boat is used primarily in salt water, wax the hull monthly and apply corrosion inhibitor to all hardware.

SACRIFICIAL ANODES

Anodes (sometimes called “zincs”) are used to protect hardware exposed to the water. Since galvanic corrosion attacks the least “noble” metals first, less noble metal anodes are used to purposefully “sacrifice” themselves, thereby protecting the more noble metals of the drives, propeller, tabs, boarding platform and other metal items below the waterline (such as underwater gear).

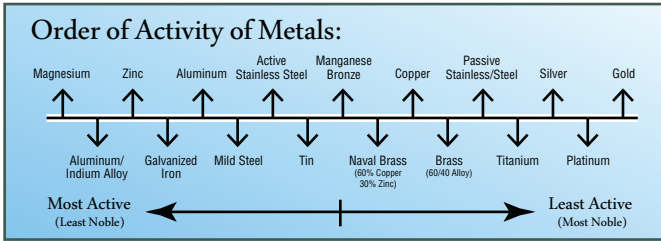

KC-6009

Anodes may be installed on the boat transom and/or bottom at the factory. Additional anodes may be installed on the underwater gear as well as any metal components exposed to seawater, such as engine and air conditioning heat exchangers and water cooling jackets. Anodes are made in three different metals which must be matched to the water type and local conditions. Most boats are equipped from the factory with zinc anodes on the recommendation from engine and drive manufacturers. The anodes that are installed on the trim tabs are typically zinc and are isolated from the boat bonding system.

Selection, monitoring and replacement of the anodes on the transom, drives, trim tabs, boarding platform supports and other underwater gear is very important and the customer’s maintenance responsibility. Any damage done because of lack of maintenance will not be covered under warranty.

WATER TYPE	ANODE MATERIAL	REPLACE AT
Salt water	Zinc	40% decomposition
Brackish water	Aluminum	50% decomposition
Fresh water (clean)	Aluminum/magnesium alloy	50% decomposition
Fresh water (polluted)	Magnesium	40% decomposition

**NOTICE**

To be effective, anodes must be bare metal. If the boat is dry-docked more than 24 hours, sand the anodes to clean oxidation from the surface.

- Zinc and aluminum anodes left in fresh water or zinc anodes used in brackish water will become covered with white oxide which effectively stops the sacrificial process and exposes the underwater gear to damage.
- Do not paint sacrificial anodes. Bottom paints/sealants on anodes will block the sacrificial process and expose the underwater gear to damage.
- Depending on local conditions, some anodes can deteriorate very quickly and must be closely monitored. See the boat dealer for recommendations.

Because of the vital function that anodes play in the protection of underwater gear, replace anodes at the recommended level of decomposition, or annually, with the correct type. Boats stored in salt water will normally need to have the anodes replaced every 6 months to one year. Anodes requiring replacement more frequently may indicate a stray current problem within the boat or at the slip or marina.

Anodes that do not need to be replaced after one year may not be providing the proper protection. Loose or low-quality anodes could be the problem. There could also be a problem in the bonding system or the wrong anode material is being used.

The boater/customer has the responsibility in maintaining and ensuring that the proper anodes are installed for the area (water) in which the boat will be used. See the boat dealer about changing material or adding additional anodes.

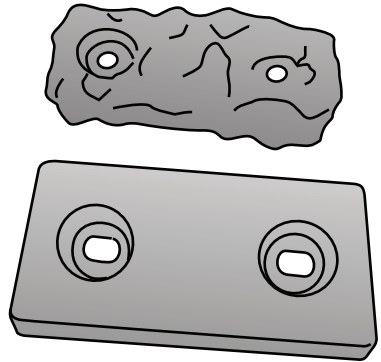

KC-6006

HARDWARE, FASTENERS AND FITTINGS

Check all fasteners, fittings, hinges, latches, rails and cleats for corrosion and tightness. Repair or replace any items that need attention. Never use automotive replacement parts when replacing marine parts.

Periodically clean all hardware with approved marine cleaners or mild soap and water. Never use abrasive cleaners or materials; they will scratch the polish and protective coatings on the hardware and cause the hardware to corrode. Applying a coating of marine-grade wax can help maintain the original shine of the hardware and help prevent corrosion.



ELECTRICAL SYSTEM

Before performing any work on the electrical system or the battery, review *Safety in Section 2*.

⚠ WARNING *Shock Hazard: Use extreme caution when checking for an electrical problem.*

An electrical system problem must be treated seriously. Do not operate the boat knowing there is a problem with the system. When a problem is discovered, have your G3 dealer service it immediately.

NOTE — The electrical system is designed to protect the boat from short circuits or an overload condition. Any modifications to the system should be done by your G3 dealer.

BATTERIES

⚠ WARNING *Electrical Shock Hazard: Always disconnect the batteries before performing maintenance on the DC electrical system. Electrical shock may occur if the batteries are not disconnected during maintenance on the DC electrical system.*

⚠ WARNING *Personal Injury Hazard: Always wear gloves and protective eyewear when working on and around the batteries. The batteries contain an acid called electrolyte. Avoid causing damage that could spill electrolyte into the bilge when servicing the batteries. Avoid getting salt water in or on the battery. Either condition can create a poisonous gas that is harmful if inhaled. Always disconnect the batteries before cleaning.*

⚠ CAUTION *Personal Injury Hazard: Never allow a tool to bridge across the battery terminals. Injury can result if the terminals are accidentally bridged with a tool or other conductor.*

Today's boats can be loaded with electronics that all run off the boat's battery. Because of this, many boats will have two or more batteries: one for starting and running the engine, and one for electronics, commonly referred to as the house battery. One advantage is that the starting battery will not be drawn down when using electronics with the engine off, such as with a stereo. Another advantage is if the starting battery has lost capacity because of age, the battery switch has a 1+2 (Both) position that parallels both batteries for emergency starting. See the *Battery Switch* section of this manual for more information.



Marine batteries generally come in two types: starting and deep-cycle. Starting batteries are similar to car batteries, can supply lots of current for a short period of time and are used for starting the engine. Starting batteries should be recharged almost immediately and do not tolerate deep discharges. Deep-cycle batteries are designed for repeated discharging and recharging cycles without damage. They are used as the house battery on boats with higher DC power requirements.

All batteries have one thing in common — they run for a while, need recharging and require an eventual replacement as the capacity fades. Most marine batteries are sealed and require no maintenance other than keeping them at a full state of charge and diligently cleaning corrosion from the terminals. To maintain long life, deep-cycle batteries should not be discharged more than 50% before they are recharged.

Most marine batteries are flooded, sealed lead-acid, but there are several different battery types/chemistries that could be used. You must use caution when charging or replacing the batteries; replace batteries with the exact same type, group and capacity. If your boat is not equipped with an onboard battery charger, use a smart charger suitable to your battery type/chemistry.

**CAUTION**

Burst Hazard: Never use an automotive type (lead-acid) battery charger to charge a gel cell type battery. Doing so will cause damage to both the charger and battery and can cause the battery to burst. Use a battery charger specifically designed to charge gel cell type batteries.

Always turn off the battery switch (if equipped) or disconnect the negative battery cable before servicing the electrical system.

NOTICE

The following information applies to lead-acid batteries. If you replace the batteries with batteries using different chemistry such as Li-Ion, you must follow the battery manufacturer's instructions for inspection, maintenance and charging.

Refer to the OEM information for operation details.

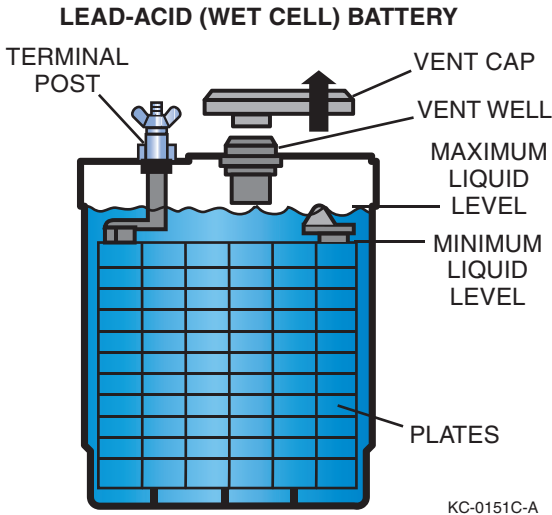

When you install a battery:

- Make sure the battery terminals are clean.
- Be certain to use correct polarity when you connect the battery cables to the battery.
- Make sure the cable connections are tight.
- Always shut down the engine before removing or attaching battery cables and never run the engine with the battery cables disconnected.
- Always remove the negative (-) cable first. Always attach the negative (-) cable last.

Check the battery frequently for signs of corrosion. If corrosion is evident, clean the terminal posts with a baking soda and water solution and a wire brush. Disconnect the battery terminals before cleaning.

WARNING *Burn Hazard: Lead-acid battery fluid can cause severe burns.*

Check the fluid levels in the cells.

NOTICE *Some batteries are sealed and cannot be filled. A level of approximately 1/4 to 1/2 in. (6 to 13 mm) above the plates is sufficient. If needed, fill with distilled water; do not overfill.*



During extended periods of non-use, batteries will self-discharge and should be recharged. Before recharging, disconnect the battery terminals and remove the battery from the boat. Recharge the battery according to the directions enclosed with the battery and battery charger. When installing the battery in the boat, make sure the battery is secured in the battery box, the terminals are tight and all protective covers are in place.

**WARNING**

Fire/Explosion Hazard: Hydrogen gases produced by a lead-acid battery while it is charging, or the engine is running, can cause a fire and/or an explosion.

DIRECT BATTERY CHARGING

Secure the battery compartment doors in the OPEN position. Observing polarity, connect the battery charger to the battery posts.

ONBOARD CHARGER

Charging through the onboard charger can be performed by securing the battery compartment doors in the OPEN position. First, place the receptacle end into the permanently mounted charger inlet on the boat. Then, plug a properly grounded extension cord into a 110-volt AC outlet. Charging will begin automatically.

BILGE SYSTEM

A boat's bilge area accumulates oil and greasy dirt over a period of time and should be cleaned periodically. Consult the boat dealer for recommendations on special bilge cleaning products and procedures.

BILGE PUMP

Periodically check the bilge pump(s) inlet screens and hoses for obstructions and debris. Foreign materials can clog the screen and hoses or become lodged in the bilge pump impeller, which can cause the pump to malfunction. Periodically check the operation of the bilge pump and float switch, if equipped. Inspect all wiring, clamps and hoses for tightness on a regular basis.

ENGINE

The manufacturer of the boat's engine(s) will provide a separate maintenance procedure. See the *Engine Operator's Manual* for specific information on maintenance procedures.



FUEL SYSTEM

 **WARNING** *Fire/Explosion Hazard: Gasoline is extremely flammable and highly explosive under certain conditions.*

Be sure to check the fuel hoses and connectors for leaking and deterioration before fueling and on a monthly basis.

Fuel vents are normally located in the deck in the same general area as the fuel fills. Periodically check that the fuel fills and vent lines are free of obstructions and kinks.

Check and/or replace the fuel filter periodically or clean as needed. If the filter has a water separator valve, use a catch container beneath the valve and open the valve to drain the water. Check fuel lines, vent hoses and drain hoses frequently for leaks. Replace any worn or cracked hoses.

Tightening a fitting or clamp may correct a fuel leak. If the leak continues, however, replace the line, fitting or hose immediately to prevent a build-up of fluids or gases.

Use fuel system parts certified for marine use only. Never use automotive parts in marine applications. Modern fuel systems are more complex and should only be serviced by a marine technician certified in fuel systems.

STEERING SYSTEM

Frequently inspect the steering system for smooth, free and full-range operation. In addition, check the original self-locking nuts used to fasten the steering link rod between the steering cable(s) and the engine.

Have your G3 dealer check for proper lubrication, any unusual backlash and any component wear of the steering system at least once a year.

GENERAL CLEANING AND MAINTENANCE

 **WARNING** *Asphyxiation Hazard: Do not mix cleaning agents together; toxic vapors may be released. Read and follow safety-related precautions found on the product labels.*



MARINE GROWTH

If accelerated marine growth is a problem in your area, an antifouling bottom paint may be necessary to slow growth and prevent gelcoat damage. Before selecting a bottom paint, talk to the boat dealer to determine which product works best in your area. Many local variables can affect the selection of paint. Be sure to follow the paint manufacturer's directions exactly.



CAUTION

When choosing an antifouling or protective bottom paint for your boat's aluminum hull, do not use any paint that contains copper or copper derivatives that may cause galvanic corrosion.

CLEANING

Never allow any type of cleaning solution or cleaning material to come in contact with the water or be discharged into the water. The discharge of any type of debris or waste, including, but not limited to, food, trash, garbage, oil, fuel, liquids and human waste, is highly restricted, if not unlawful, in most waterways. Never discharge anything into the water.

Periodic cleaning is the best way to keep the boat looking new. Regular washing and waxing keep dirt, algae and water deposits from building up and deteriorating the finish. Keeping the boat in "show room" condition means greater personal satisfaction and higher resale value. Special cleaning products are available from the boat dealer.

HULL

When washing the boat, use a mild detergent with a warm water solution. Never use any kind of alkaline cleaners such as Tri-Sodium Phosphate (TSP), abrasive cleaners, solvents, ammonia or chlorine to clean gelcoat surfaces, as these will damage the gelcoat surface. Special cleaners are available from the boat dealer to remove marine growth and algae from the hull.

Wax gelcoat surfaces at least twice a season. Special marine gelcoat waxes are available from the boat dealer to prevent color fade and dirt adhesion. If the gelcoat has oxidized, chalked, dulled or faded from lack of proper maintenance, buffing may be necessary to bring back the shiny appearance. Hand buffing with #7 rubbing compound or power buffing with glazing compound #1 will quickly restore the surface; however, always seek certified assistance before attempting to restore your boat's finish.



VINYL UPHOLSTERY

Regular washing with warm, soapy water and a medium-soft brush is sufficient to keep the cushions, canopy top and other vinyl coverings in good condition. Keep the cushions from becoming soaked and dry off thoroughly after washing to prevent mildew accumulation after the boat is covered. Position the cushions up in the boat when covered to allow air circulation and spray with mildew repellent.

NOTICE

Certain automotive, household and industrial cleaners can cause further damage and discoloration. Be cautious when using solvents and dry-cleaning fluids, or products that contain dyes such as waxes. Whenever cleaning stubborn stains, test the treatment in an unseen area first. Use the following stain treatments with discretion. Between steps, be sure to rinse thoroughly with plenty of clean water and allow to dry.

For tough stains on vinyl, clean the stain as quickly as possible to prevent it from taking a set. Note that some products such as suntan lotion, shoe polish and wet leaves may stain permanently.

NOTICE

Never attempt to clean vinyl, canvas, flooring, or bimini tops with a pressure washer, gasoline, kerosene, or acetone. Do not use a pressure washer on the interior of the boat for any reason or damage will occur.

Although not always convenient, minimizing the boat's contact with damaging ultraviolet (UV) rays and storing removable seats and canopies indoors when not in use will increase the longevity of vinyl upholstery.



VINYL CARE AND CLEANING GUIDE

TYPE OF STAIN	STEPS:	1	2	3	LEGEND
General care		A	B		A = Medium-soft brush, warm soapy water, rinse/dry B = 303 Fabric and Vinyl Cleaner [®] , rinse/dry C = Wipe or scrape off excess (chill gum with ice beforehand) All cleaning methods must be followed by a thorough rinse with clean, warm water. Failure to care for your vinyl properly or use of improper cleaners may void your warranty and damage your vinyl.
Dirt buildup		A	B		
Ballpoint ink*		B	A		
Chewing gum		B	A		
Coffee, tea, chocolate		B	A		
Grease		C	B	A	
Household soil		A	B		
Ketchup		A	B		
Latex paint		A	B		
Lipstick		C	A	B	
Mildew or wet leaves*		B	A		
Motor oil		C	B	A	
Oil-based paint		C	B	A	
Permanent marker*		B	A		
Spray paint		B	A		
Suntan lotion*		A	B		
Tar / Asphalt		C	B	A	
Yellow mustard		A	B		

* May leave a permanent stain

Recommended Products

- Mild dish soap
- 303[®] Fabric & Vinyl Cleaner

Non-Recommended Products

- ArmorAll[®]
- Bleach
- Baking soda
- Fantastik[®]
- Formula 409[®]
- Murphy[®] Oil Soap
- Simple Green[®]
- STP[®] Son of a Gun![®]



CANVAS COVERS AND BIMINI TOPS

In most cases, boat canvas receives more abuse than any other item on a boat. Canvas must be regularly maintained for long life and top performance. Moisture, dirt and chemicals from industrial fallout, heat, ultraviolet rays and salt water can all contribute to the deterioration of canvas. These elements can cause serious damage if left unchecked. The following guidelines will help you keep your canvas in good condition for years to come:

- Convertible tops are not designed for extended exposure to the elements as a protective cover at dockside or when the boat is in storage. Use a full, properly fitted, light-colored mooring cover for these purposes.
- If canvas gets wet during use, remove any side curtains and open the windshield to allow both sides and all seams to dry. The air circulation will allow all canvas to dry and prevent the growth of mildew. Never store wet or damp canvas.
- Occasionally set up all canvas and curtains, and hose down with fresh water to remove accumulated soot and dirt. Sweep or brush the underside of the canvas to prevent the accumulation of dirt and mildew.
- Wet canvas must be allowed to dry thoroughly before storage. Never allow canvas to dry loose since shrinkage can occur. Install and stretch all canvas fully on your boat when drying.
- Never allow the canvas to be exposed to direct sunlight for long periods of time.
- Use care when handling clear vinyl curtains and windows to prevent scratching. Never use cleaners on clear vinyl curtains and windows. Use clean water and a soft, clean cloth.
- Never fold canvas where creases can form in the material. Loosely roll canvas to prevent damage.
- Never store canvas in plastic bags. Store canvas in a dry, well-ventilated compartment.
- Outer canvas surfaces can be cleaned with a soft scrub brush and either automotive convertible top cleaners or household cleaners suitable for use on vinyl surfaces. The underside of the canvas may be periodically sprayed with a spray disinfectant to prevent mildew.
- Never store or dock the boat under trees. Tree sap is very corrosive to canvas and can also be harmful to gelcoat and vinyl interiors.
- Adjust canvas top bows to eliminate pockets in which rainwater can accumulate. The weight of accumulated water can collapse or damage the canvas top.
- Lubricate snaps and zippers regularly. Vaseline, silicone spray or paraffin are effective lubricants. Never force snaps and zippers that are stuck.
- Never trailer the boat with the convertible top in the mounted position. Dismantle, roll and securely store all canvas while trailering your boat to prevent wind damage.



NON-SKID FLOORING

Your boat may use synthetic non-skid material for flooring, swim platform and other stepping surfaces to enhance traction and reduce slips and falls. This material is comfortable underfoot, easy to clean and highly stain resistant. However, as with any product in the marine environment, regular care and cleaning will keep the material looking its best for many years.

Care

Non-skid material is UV protected; however, certain conditions may accelerate fading or damage from the sun, especially on vertical surfaces due to Light Amplification (LA), which can cause sun burning. LA simply means that in addition to direct sunlight, additional sunlight reflected from shiny surfaces such as gelcoat or stainless steel/chrome hardware can be focused on the material and heat it beyond its maximum temperature range. Since sun burning is not covered by your warranty, keep the following points in mind to minimize LA damage:

- Whenever possible, cover the boat/material when kept outdoors.
- Keep objects that can refract light such as pool toys or water bottles off the material as much as possible.
- Consider adding more material to reflective vertical areas that focus on the material.

Cleaning

Regularly clean non-skid material to extend its life. Immediately remove sand, dirt, spills and stains to help avoid drastic cleaning measures. See your dealer for recommended cleaning products and always start with vacuuming loose dirt and sand. Always read the use and safety instructions for cleaning products.

For normal cleaning, spray approved cleaner liberally to cover the affected area. With a medium-bristled boat brush, lightly work the product in. Let the cleaner sit for 3-5 minutes, then use water to dampen the affected area and lightly scrub for a second time. Rinse the cleaner off thoroughly and dry the area with a clean towel.

To clean dirt, footprints, etc., use an all-purpose cleaner, degreaser or dish soap along with warm water and a medium-bristled boat brush. Thoroughly work the soapy mixture into the material. Rinse the area with clean water and repeat if necessary.

To remove suntan lotion, use an all-purpose cleaner or degreaser along with a medium-bristled boat brush. Put small amount of the cleaner on the oil stain and use a medium-bristled boat brush and warm water to scrub until the oil disappears. Rinse the area with clean water and repeat if needed.

To remove fish blood, mix one cup of bleach with one gallon of warm water. Using a soft-bristled boat brush, scrub in a circular motion until the fish blood surfaces.



Rinse thoroughly with clean water and repeat if necessary. If not effective, see the following instructions on removing rust stains.

To remove rust stains, use a capful of vinegar or oxalic acid. Apply it to the rust stain and allow it to soak for 3-5 minutes. If necessary, use latex/nitrile gloves to massage the cleaner into the texture of the material. Rinse the area with water and repeat if necessary.

NOTICE

When applying oxalic acid, use care to avoid getting acid on the edges of the material, as it could damage the lamination.

CARPET

Occasional vacuuming and washing with mild detergent and warm water or household carpet cleaners will keep the carpet clean. Thoroughly wash the detergent out of the carpet with clean water. Let the carpet dry in the sun to prevent any mildew or odor caused by moisture.

To clean mildew off the carpet, first check the cleaner on a small area of carpet that is hidden to determine compatibility of cleaner and carpet. "FISH ATTRACTANTS," which are commonly sprayed on lures and some insect repellants, will cause deterioration of the carpet backing. Spray these formulas away from the boat carpet and clean any spills promptly. DO NOT use pressure sprayers to clean boat carpet.

WINDSHIELD

A clean windshield is important. If the boat is equipped with a glass windshield, applying a nonabrasive glass cleaner with a soft cloth will remove most dirt. Clean tinted Plexiglas or plastic windshields with a mild soap solution and damp cloth only. Harsh detergents, solvents, chemicals or dry cloths used on any glass or plastic windshield will scratch the surface.

MOORING AND TRAILERING COVERS

A mooring cover is typically a lightweight nylon cover used when the boat is moored or docked on the water and that can be quickly fitted on the boat. A trailering cover is a heavier canvas and can be securely fastened to the boat/trailer for highway use. Both types cover the entire boat and offer protection from sun, wind and rain. In most cases, boat covers receive more abuse than any other item on a boat due to exposure to the elements.

GENERAL CARE AND MAINTENANCE

Covers should be regularly maintained for long life and top performance. Moisture, dirt, chemicals from industrial fallout, heat, ultraviolet rays, tree sap and salt water can all contribute to the deterioration of covers. Covers are recommended to protect your investment; the following guidelines will help you keep your covers in good condition:

- Always follow any written maintenance instructions from the cover manufacturer.
- Never use a mooring cover for trailering or winter storage.
- Never store or dock the boat under trees. Tree sap is very corrosive to covers and can also be harmful to gelcoat and vinyl interiors.
- Adjust cover top bows/poles to eliminate pockets in which rainwater can accumulate. The weight of accumulated water can collapse or damage the cover. Poles should be extended to maximum height possible.
- Wet canvas must be allowed to dry thoroughly before storage.
- Covers can be cleaned with a soft scrub brush and either automotive convertible top cleaners or household cleaners suitable for use on vinyl surfaces. The underside of the cover may be periodically sprayed with a spray disinfectant to prevent mildew.
- For best results when installing a cover, start with the aft corner on one side, then bow corner on the same side, then apply clips/snaps/straps on that side. Unfold cover to opposite side and repeat.

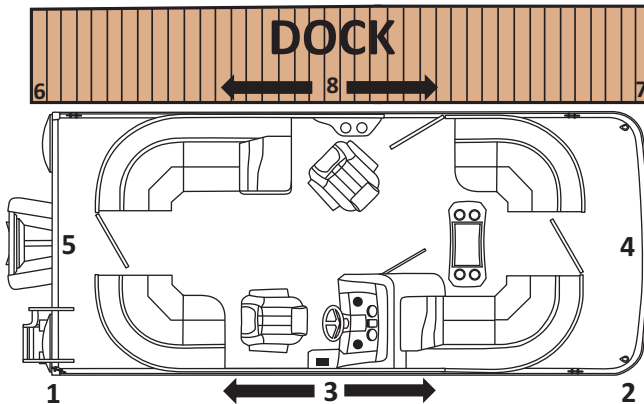

KCB-0107



WINDOW CHANNELS

Nylon pile is typically used in sliding window channels. Never use any products that contain bleaching solutions to clean window channels or seals. Use only a mild detergent and water solution for cleaning. If windows stick, spray the channels with silicone spray while working the window back and forth.

TEAK

If your boat is equipped with teak wood, consult your dealer for cleaning, maintenance and refinishing.

TRAILER

Periodically check the general trailer components for damage, general condition and operation when applicable. Always replace trailer components that are in question or in need of repair.

- Lights
- Electrical connectors
- Tires (condition and pressure)
- Wheel lug nuts and studs
- Wheel valve stems
- Wheel bearings
- License plate and holder
- Rollers, bunks and hardware
- General fasteners (missing, loose or corroded)
- Safety chains or straps
- Winch, winch strap and hooks
- Trailer coupler and latch
- Frame, axle and springs
- Spare tire and wheel
- Brakes and actuator assembly



STAINLESS STEEL AND CHROME HARDWARE

Stainless steel and chrome will normally oxidize over time, especially in marine environments. Cleaning and preventive maintenance of stainless steel and chrome hardware are crucial in maintaining appearance and functionality. If the hardware is left unattended, it can corrode, causing the hardware to appear unsightly and cause structural integrity problems.

Wash the stainless steel and chrome hardware with mild soap and water after operating the boat in corrosive environments such as salt water.

Remove rust or corrosion promptly by cleaning the hardware using a high-quality stainless steel, chrome cleaner or conditioner. Do not use any abrasive materials such as steel wool or sandpaper to clean the hardware. Do not use acids or bleach or any cleaners not intended for stainless steel or chrome, such as glass, tile or counter cleaners, as these types of cleaners can cause permanent damage. Always test a cleaner in an inconspicuous area first before applying to the complete surface.

After cleaning, protect the surface of the hardware by using a high-quality boat, automotive, stainless steel or chrome protectant or wax.

ALUMINUM HARDWARE

Periodically wash aluminum hardware with soap and water to keep it clean. If the boat is used in salt water or polluted water, wash aluminum hardware with soap and water after each use. Salt water allowed to remain on aluminum will penetrate the metal and corrode the aluminum.

It is recommended to frequently clean and coat all aluminum hardware with a metal protectant made for aluminum to protect against pitting and corrosion caused by the harsh effects of salt water. Choose an appropriate cleaner specific to your needs, as special cleaners are available for different types of aluminum hardware such as anodized, powder coated and polished.

Most stains can be removed from aluminum with a metal polish or fine polishing compound. To minimize corrosion, use a caulking compound or Teflon-based sealer to isolate hardware and fasteners mounted to aluminum fabrications. With proper care, aluminum hardware can provide many years of service.



SECTION
11 GENERAL CARE AND MAINTENANCE

This Page Intentionally Left Blank

Section 12

WINTERIZATION AND STORAGE

The boat may be equipped with a variety of specialized systems and components. The following basic and typical information may not apply to your specific application. This section may not cover all systems or components on the boat. Consult the boat dealer for assistance.

Winterizing or storing the boat for extended periods of non-use requires special preparation to prevent boat and system damage. Without proper preparation, if the boat is not used or is stored for extended periods of time, internal parts of the engine may become corroded from lack of lubrication. If the boat is stored in freezing temperatures, water inside the bilge, engine cooling system or boat water systems may freeze and cause damage. Be sure to keep up with all annual maintenance during winterization.

Before performing any winterization and storage procedures within this section, review *Safety in Section 2*.

LIFTING

NOTICE

Consult the boat dealer for proper preparation and lifting instructions for the boat.

Attempt to lift or hoist boats only if you are qualified or experienced with this procedure. This procedure requires special equipment and experience. Do not attempt to lift or hoist the boat alone; damage, personal injury or death can occur.



WARNING

Crush Hazard: Do not attach lifting cables to the bow eye, cleats, water-ski tow eye, or grab handles. Serious injury to persons or damage to the boat can occur. Use only a sling designed specifically for lifting boats.

Empty water and water tanks and winterize applicable systems prior to removing the boat from the water. Consult the information for propulsion, water, waste, air conditioning and fuel systems before removal from the water. Improper winterization, lifting and storage is not covered by the warranty.

If the boat is to be removed from the water without a trailer, follow these guidelines:

- Cover lifting cables with a rubber hose or other protectors to prevent damage to the finish.
- Attach guidelines to the bow and stern to control movement.
- Use spreader bars and keep lifting pressure vertical to prevent side load damage.



- Keep the bow slightly higher than the stern to prevent engine damage.

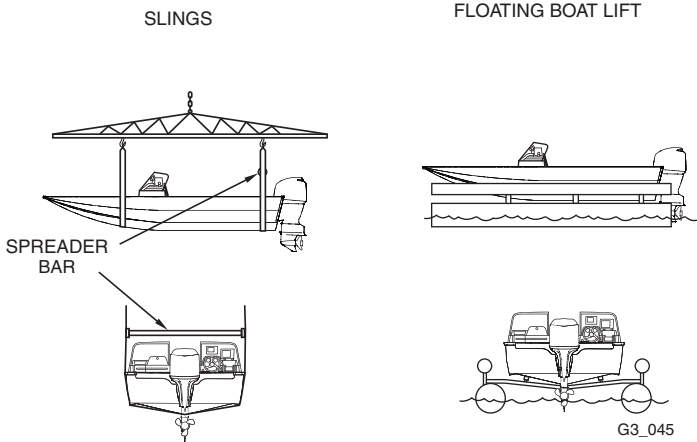

WINTERIZATION AND STORAGE PREPARATION

The following procedures will help prevent damage to the boat:

- While the boat is still in the water, add the proper amount of fuel stabilizer/conditioner according to the engine manufacturer's recommendations. If the boat contains fuel with ethanol, pump-out as much as possible before removing the boat from the water. Operate the boat for at least 15 minutes to be sure that the treated fuel has reached the engine.

NOTICE

If you plan to store the boat for more than three months in either a humid environment, extreme temperatures or outdoors, "fog" the engine with a corrosion-preventing fogging oil according to the propulsion system manufacturer's recommendations. See the Engine Operator's Manual for more information.

- Once the boat is removed from the water, remove the bilge drain plug immediately. Store the drain plug in a plastic bag and tape it to the throttle control lever for easy accessibility the next time you use the boat.
- Drain the livewell system.
- Inspect all sacrificial corrosion protection anodes for excessive wear and replace as necessary.
- Check all thru-hull fittings and other fasteners for tightness and leakage.



WINTERIZATION AND STORAGE

- Thoroughly clean the hull, deck and interior of the boat as soon as you remove it from the water; marine growth is easier to remove when it is wet.
- Always allow all boat compartments to air dry for a couple of days to prevent mildew from trapped moisture. If you use shrink wrap, always allow for ventilation to prevent mildew from trapped moisture.
- Apply a coat of wax to the entire surface of the boat and rust inhibitor on all metal parts.
- Clean all traces of dirt, oil, grime and grease from the engine and bilge.
- After washing, raise the bow of the boat high to allow as much water as possible to drain while performing other storage preparations.
- Touch up areas where paint has been removed.
- Prepare the engine for storage according to the *Engine Operator's Manual*. Flush the engine cooling system with clean water and/or a nontoxic antifreeze mixture approved for marine use. Never exceed the maximum engine rpm for flushing recommended as stated in the manual.
- Perform all scheduled maintenance for the engine and boat equipment. See the *Engine Operator's Manual* and all equipment manufacturer's information for periodic and annual maintenance procedures.
- Turn off all electrical switches and breakers.
- Remove all batteries from the boat. Clean, fully charge and store the batteries in an area outside the boat not subject to freezing temperatures. Never store batteries close to heat, sparks or open flames.
- Clean all interior upholstery, furniture, appliances, etc.
- Pest/rodent repellents may help prevent damage to the boat during storage.

STORING ON A CRADLE OR BLOCKS

- When storing a boat on support other than the proper trailer, make sure the hull is supported properly to prevent hull damage. Most cradles are custom-built to support the boat's hull.
- Put the cradle, stands or blocks on a hard, level surface capable of supporting the combined weight of the cradle and the boat.
- When using blocks with jack stands, always use jack stands that are rated for more than the required load, making sure they are securely positioned so they cannot move under the load. Use a minimum of three blocks to support the keel and each side of the boat where applicable. Use a minimum total of nine jacks and/or blocks.

**If stored outside:**

- Position the boat to allow for adequate draining from rain or snow.
- Cover the boat to prevent the collection of rain, snow or debris. When using a cover, allow ventilation for residual moisture and condensation to escape. Never cover or plug the bilge drain hole.

NOTICE

Mooring covers are not designed to be used to protect the boat when stored outside. Use a high-quality, properly fitted canvas cover with suitable support for expected snow loads.

- Position the lower unit drive in the DOWN position.

STORING ON A TRAILER

- Be sure the trailer supports are adjusted to properly support the boat's hull.
- Park the trailer and boat in a protected area with the lower unit drive in the DOWN position.
- Loosen tie-downs and winch line, but be sure the boat is resting properly on hull supports.
- Lift the trailer and place blocks under the trailer frame to relieve weight on trailer tires and springs. Position the boat to allow for adequate draining from rain or snow.
- Cover the boat to prevent the collection of rain, snow or debris. When using a cover, allow ventilation for residual moisture and condensation to escape. Never cover or plug the bilge drain hole.

STORING DURING THE SUMMER

The best way to store your boat is under a boat house or storage roof. A mooring cover will help reduce the effects of sun and dirt. The mooring cover can repel most water but will collect water during heavy downpours. Always remove collected water after a rain to help prevent tearing and staining. The mooring cover can suffer damage from high winds, so take proper precautions to prevent damage when possible. If you desire a canvas cover that can also withstand heavier loads, contact your dealer to get information on a custom storage cover from a local canvas maker.



RECOMMISSIONING AFTER STORAGE

- Check tire pressure and lug nut tightness on the trailer.
- Inspect the hull for damage.
- Charge and install all batteries.
- Remove blocks from under the trailer frame.
- Tighten tie-downs and the trailer winch line.
- Check the bilge blower vents for obstructions and blower operation.
- Check the bilge pump and float switch for proper operation.
- Inspect all battery and electrical wiring for loose connections and/or damage.
- Check the fuel system for leaks or damage. Verify the condition of all hoses and fuel line. Should a fuel hose need replacing, use only USCG-approved hose. Check hose labels for exact type of replacement. Be sure all hose clamps are tight.
- Check the engine and bilge for signs of nesting animals; clean as necessary.
- Check the entire engine for cracks and leaks caused by freeze damage.
- Check the condition of all hoses and clamps for tightness.
- Clean the bilge area and install the boat bilge drain plug.
- Lubricate all seacocks and check for proper operation.
- Install all drain plugs in strainers and seacocks.
- Close all drains and valves that were opened during winterization.
- Perform any annual maintenance not performed during winterization. See the propulsion and equipment manufacturer's information for periodic and annual maintenance procedures.
- Check all raw water intake areas and screens for obstructions.
- Check and lubricate the steering system.
- Check all navigational lights.
- Check all controls, gauges, boat systems, accessories and related equipment for proper operation.
- Check all fire extinguishers for charge level and expiration date.
- Inspect all safety equipment for condition and operation as applicable.
- Add fuel to the fuel tank. Add only enough for one week.
- When possible, briefly start and run the engine(s) using proper water supply equipment to check that the engine does start and there are no major operational problems.

**NOTICE**

If fogging oil was used during winterization, the engine will emit excessive white smoke upon initial start-up. This condition is normal and will diminish once the fogging oil has been cleared through the engine.

- Once the boat is in the water, start the engine.
- Start the engine(s) and watch the gauge readings closely, checking for leaks and abnormal noises.
- Keep speeds low for the first 15 minutes until the engine has reached normal operating temperature.
- See the *Engine Operator's Manual* and all equipment manufacturer's information for additional recommendations.

Section 13

TROUBLESHOOTING

The following information will assist you in identifying basic performance, mechanical and electrical problems. This information is intended as a general troubleshooting guide and may describe items that are not applicable to the boat.

The tachometer can be very useful when troubleshooting the boat's performance problems. A typical engine should maintain the same operating rpm throughout the useful life of the boat. When the normal operating rpm is known, that rpm should be used as a starting point when performance problems arise.

If you detect a problem with the engine, see the *Engine Operator's Manual*. If you detect an equipment or boat system problem, see the manufacturer's information for that item.

Before performing any troubleshooting procedures within this section, review *Safety in Section 2*.

NOTICE

Certain problems may require specialized skills and tools. Always consult qualified personnel before making any repairs or modifications.

PROBLEM	POSSIBLE CAUSES
Engine will not crank	<ul style="list-style-type: none">• Engine emergency stop switch lanyard not connected• Shift/throttle control not in the NEUTRAL position• Battery switch is in the OFF position• Main circuit breaker open• Battery terminals or wiring connections corroded• Low battery voltage• Faulty ignition switch/FOB battery dead• Engine problem
Engine cranks but will not start	<ul style="list-style-type: none">• No fuel in tank• Fuel tank valves closed to engine• Fuel filter clogged• Flame arrestor dirty, if equipped• Contaminated fuel• Engine problem



PROBLEM	POSSIBLE CAUSES
Poor boat performance	<ul style="list-style-type: none">• Improper power trim position• Improper trim tab position• Uneven load distribution• Excessive load• Contaminated fuel• Improper propeller selection• Excessive water in bilge• Damaged or obstructed propeller• Marine growth on hull• Damaged hull• Plugged flame arrestor, if equipped• Engine/network system problem
Throttle/shifting control problems	<ul style="list-style-type: none">• Corroded cable• Excessive bends or kinks in cable• Engine/network system problem
Excessive vibration	<ul style="list-style-type: none">• Damaged or obstructed propeller• Bent propeller shaft• Engine/network system problem
Electrical problems	<ul style="list-style-type: none">• Blown fuse/breaker or open circuit• Weak or discharged battery• Loose or corroded wiring connections• Defective switch or gauge• Loose shore power connection
Erratic or no speedometer reading	<ul style="list-style-type: none">• GPS antenna blocked or cable loose• Speedometer gauge faulty

Section 14

GLOSSARY OF NAUTICAL TERMS

ABOARD – On or in the boat.

ABYC – American Boat and Yacht Council, Inc.

AFLOAT – On the water.

AFT – Toward the rear or stern of the boat.

AGROUND – Touching bottom.

AMIDSHIP – Center or middle of the boat.

ANCHOR – (1) An iron casting shaped to grip the lake bottom to hold the boat.

(2) The act of setting the anchor.

ASHORE – On the shore.

ASTERN – Toward the stern.

AUTOMATIC CHARGING RELAY (ACR) – An ACR parallels (combines) batteries during charging, and isolates them when charging has stopped and after battery voltage has fallen. An ACR is intended to keep a load from discharging both of the batteries.

AUTOMATIC IDENTIFICATION SYSTEM (AIS) – An automatic tracking system used on ships and by vessel traffic services (VTS) for identifying and locating vessels by electronically exchanging data with other nearby ships, AIS base stations, and satellites.

BAIL – To remove water from the bottom of the boat with a pump, bucket, sponge, etc.

BAITWELL – A miniature livewell used to store and keep live bait alive and healthy.

BEAM – The widest point on the boat.

BEARING – Relative position or direction of an object from the boat.

BILGE – The lowest interior section of the boat hull.

BILGE KEELS – The raised areas or aluminum extrusions on the bottom of a boat that parallel the keel.

BOARDING – To enter the boat.

BOUNDARY WATERS – A body of water between two areas of jurisdiction; i.e., a river between two states.

BOW – The front of the boat.

BULKHEAD – Vertical partition (wall) in a boat.

BUNKS – Hull supports on trailer that may be covered with carpet, plastic or rollers.

BURDENED BOAT – Term for the boat that must “give-way” to boats with the right-of-way.

CAPACITY PLATE – A plate that provides maximum weight capacity and engine horsepower rating information. It is located in full view of the helm.

CAPSIZE – To turn over.

CAST-OFF – To unfasten mooring lines in preparation for departure.

CENTER LINE – A lengthwise imaginary line which runs fore and aft with the boat's keel.

CHINE – The point on a boat where the side intersects (meets) the bottom.

CLEAT – A deck fitting with ears to which lines are fastened.



CONSOLE – Also called helm. The steering wheel area of the boat.

CONTROLLER AREA NETWORK (CANBUS) – A robust bus standard designed to allow microcontrollers and devices to communicate with each other in applications without a host computer.

CRANKING BATTERY – The main battery used for engine starting and electrical circuits.

CURRENT – Water moving in a horizontal direction.

DECK – The open surface on the boat where the passengers walk.

DEEP-CYCLE BATTERIES – Special long-running batteries which can be repeatedly discharged and recharged without significant loss of power.

DIGITAL SELECTIVE CALLING (DSC) – A standard for sending pre-defined digital messages via the medium frequency (MF), high frequency (HF) and very high frequency (VHF) maritime radio systems. It is a core part of the Global Maritime Distress and Safety System (GMDSS).

DOLLY WHEEL – A rolling jack assembly at the front of the trailer used for positioning the coupler during trailer hookup.

DRAFT – The depth of the boat below the waterline, measured vertically to the lowest part of the hull.

ELECTRONIC LEAKAGE CIRCUIT INTERRUPTER (ELCI) – Installed with or in addition to the main shore power disconnect circuit breaker(s) to offer an additional level of protection from shore power faults.

ELECTRONIC NAUTICAL CHARTS (ENCs) – Vector data sets that support all types of marine navigation.

ELECTROLYSIS – The breakup of metals due to the effects of galvanic corrosion.

EMERGENCY POSITION INDICATING RADIO BEACONS (EPIRBs) – Safety devices carried by a vessel to alert search and rescue services and allow them to quickly locate you in the event of an emergency.

FATHOM – Unit of depth or measure; 1 fathom equals 6 feet.

FENDERS – Objects placed alongside the boat for cushioning. Sometimes called bumpers.

FORE – Toward the front or bow of the boat. Opposite of aft.

FREEBOARD – The distance from the water to the gunwale.

FUEL SENDING UNIT – The electrical device that is mounted on the outside of a built-in fuel tank and controls the dashboard fuel gauge.

GIVE-WAY BOAT – (1) Term for the boat that must take whatever action necessary to keep well clear of the boat with the right-of-way in meeting or crossing situations. (2) The burdened boat.

GLOBAL MARITIME DISTRESS AND SAFETY SYSTEM (GMDSS) – An internationally agreed-upon set of safety procedures, types of equipment, and communication protocols used to increase safety and make it easier to rescue distressed ships, boats and aircraft.

GLOBAL POSITIONING SYSTEM (GPS) – A global navigation satellite system that provides geolocation and time information to a GPS receiver.

GROUND FAULT CIRCUIT INTERRUPTER (GFCI) – A type of circuit breaker that measures current flow in the hot and neutral wires and immediately switches the electricity off if an imbalance of current flow is detected.



GUNWALE – The rail or upper edge of a boat's side.

HEAD – A marine toilet.

HELM – The steering wheel or command area.

HULL – The body of the boat.

HYPOTHERMIA – A physical condition where the body loses heat faster than it can produce it.

IN-LINE FUSE – A type of protective fuse located in the power wire of a direct current (DC) circuit usually near the battery.

KEEL – The lowest portion of the boat; extends fore and aft along the boat's bottom.

LIFE JACKET – A buoyant, wearable jacket that, when properly used, will support a person in the water; also see PFD.

LIST – Leaning or tilt of a boat toward the side.

MAKING WAY – Making progress through the water.

MARINE CHART – Seagoing maps showing depths, buoys, navigation aids, etc.

MOORING – An anchor, chain or similar device that holds a boat in one location.

NATIONAL MARINE ELECTRONICS ASSOCIATION (NMEA) – A U.S.-based marine electronics trade organization setting standards of communication between marine electronics.

NATIONAL OCEANIC AND ATMOSPHERIC ADMINISTRATION (NOAA) – An American scientific agency within the United States Department of Commerce that focuses on the conditions of the oceans, major waterways and the atmosphere.

NAVIGATION AID – Recognizable objects on land or sea such as buoys, towers or lights which are used to fix position to identify safe and unsafe waters.

NMMA – National Marine Manufacturers Association.

NO-WAKE SPEED – The speed at which a boat travels to produce an imperceptible wake.

PASSIVE HYDROLOCK – A problem that occurs when water siphons through the boat's exhaust system, enters a cylinder in the engine and results in an engine starting failure. This problem is possible on any marine vessel powered by a combustible engine with exhaust risers that sit below the waterline.

PFD – A buoyant personal flotation device used to support a person in the water; also see Life Jacket.

PITOT TUBE – See Speedometer Pickup Tube.

PLANING HULL – A hull designed to lift, thereby reducing friction and increasing efficiency.

PORPOISE – A condition in which the bow bounces up and down caused by trimming the engine too far out.

PORT – (1) The left side of a boat when facing the bow. (2) A destination or harbor.

PRIVILEGED BOAT – Term used for the boat with the right-of-way.

RIGHT-OF-WAY – Term for the boat that has priority in meeting or crossing situations. The stand-on or privileged boat.

RULES OF THE ROAD – Regulations for preventing collisions on the water.



SPEEDOMETER PICKUP TUBE – Also called pitot tube. The plastic device that extends below the bottom of the boat. It connects to the speedometer with plastic flexible tubing.

SPLASHWELL – The section of an outboard-equipped boat that is just forward of the transom.

STAND ON BOAT – Term for the boat that must maintain course and speed in meeting or crossing situations. The privileged boat.

STARBOARD – The right side of the boat when looking toward the bow.

STERN – The back of the boat.

STOW – To pack the cargo.

STRONG POINT– A dedicated eye specially reinforced for the attachment of mooring lines, anchor chains, anchor lines and tow lines.

SURGE BRAKES – A type of trailer braking system designed to automatically actuate when the tow vehicle's brakes are applied.

TRANSDUCER – The unit that sends/receives signals for the depth sounder.

TRANSOM – The transverse beam across the stern.

TRIM – Fore to aft and side to side balance of the boat when loaded.

UNDERWAY – Boat in motion; i.e., not moored or anchored.

USCG – United States Coast Guard.

V-PAD – A modified vee-hull design with a small, flat area in the keel aft.

VISUAL DISTRESS SIGNAL – A device used to signal the need for assistance such as flags, lights and flares.

WAKE – The waves that a boat leaves behind when moving through the water.

WATERWAY – A navigable body of water.

INDEX

Numerics

- 12 VDC accessory port10-16
- 5-pin wiring connector8-5

A

- About this manual1-1
- About your new boat1-2
- Accelerating and running
underway7-13
- Accessory switches10-4
- Accidents3-2, 4-6
- Accidents, collisions and giving
assistance4-6
- After refueling7-9
- Aids to navigation6-5
- Alcohol3-3
- Aluminum hardware11-21
- AM/FM stereo10-17
- America's Waterway Watch3-6
- American Boat & Yacht Council1-5
- American Red Cross1-5
- Anchor line7-21
- Anchors and anchoring7-21
- Angler and guide V typical deck
layout9-16
- Angler and guide V typical helm
layout9-14
- Anodes11-4, 11-6, 12-2
- Antifouling bottom paint11-13
- Aquatic Invasive Species (AIS)3-8
- Aquatic vegetation/weeds5-3
- Audible (sound) signals2-25
- Audible signaling devices ..2-14, 2-25
- Audible signals6-4

B

- Backing up trailer8-9
- Basic safety rules2-2
- Battery11-8
- Battery charger10-17
- Battery charging system
(if equipped)10-9
- Battery connections10-7
- Bay typical deck layout9-12
- Bay typical helm layout9-10

- Before getting underway7-1
- Before refueling7-8
- Bell6-4
- Bilge11-11
- Bilge pump11-11
- Bilge switch10-4
- Bilge system10-9
- Boarding7-3
- Boarding ladder10-17
- Boat flags5-4
- Boat information form1-8
- Boat loading7-4
- Boat operator specific
guidelines2-35
- Boat operator, occupants and
participants2-34
- Boat owner/operator
responsibilities3-1
- Boat Owners Association of
The United States1-5
- Boat setup2-5
- Boat system failure4-6
- Boat systems10-5
- Boat terminology1-2
- Boating accident3-2
- Boating equipment11-4
- Boating regulations and your
responsibilities3-1
- Boating under the influence3-3
- BoatU.S. Foundation for Boating
Safety Hotline1-5
- Bow and stern light10-15
- Bridges and shipping channels3-5
- Buffing11-13
- Buoys6-5, 6-8, 6-9,
6-10, 6-11, 6-12

C

- Canopy top (option)10-18
- Canvas covers and bimini
tops11-16
- Capacity plate7-4
- Capsizing and flooding4-5
- Carbon monoxide (CO)2-12, 2-33
- Carpet11-18



Certification standards 1-3
Checks after operation 7-15
Circuit breakers 10-6
Circuit breakers/fuses 10-6
Cleaners 11-13
Cleaning 11-13
Cleaning agents 3-9
Cold water 5-2
Collision 4-6
Commercial shipping safety
zones 3-5
Communication equipment 4-1
Compliance plate 1-3
Control operation guidelines 10-2
Controls and indicators 10-1
Controls, systems and options 10-1
Corrosion protection 11-4
Courtesy light switch 10-4
CPR 4-1
Crossing 6-2
Cruising limitations 2-31

D

Dams and spillways 5-3
Danger signal 6-4
Dangerous weather 4-6
Daymarks/Dayboards 6-6, 6-10
Debris 5-3
Design category 1-4
Direct battery charging 11-11
Disclaimer 1-4
Distress signaling devices 4-1
Distress signals 6-4
Docking 7-18
Drain plug 12-2
Driving defensively 2-29
Drugs 3-3

E

Electric trolling motor 10-16
Electrical system 10-6, 11-8
Electrolysis 11-4
Emergencies 4-1, 4-7
Emergency assistance 3-4
Emergency engine stop switch ... 2-15

Emergency preparation
checklist 4-1
Emissions 3-10
Engine 11-11
Engine cooling system 12-3
Engine emergency stop switch
and lanyard 2-16, 10-20
Engine family safety labels 9-2
Engine or boat system failure 4-6
Engine warning light 10-3
Engine-transom support
bracket 8-6
Exhaust emissions 3-10

F

Fasteners 11-7
Features and optional
equipment 10-13
Fire and explosion 4-3
Fire extinguisher 2-16
Fire extinguishers 2-15
Fires 2-16, 4-3
First aid/medical emergencies 4-1
Fishing 3-6
Flags 5-4
Float plan 7-1
Float switch 11-11
Flooring 11-17
Fog conditions 5-2
Fogging oil 12-2
Freezing temperatures 5-2, 12-1
Fuel (gasoline) 7-5, 7-6, 11-12
Fuel filler 7-8
Fuel filter 10-19
Fuel gauge 10-3
Fuel management 7-5
Fuel stabilizer 12-2
Fuel suppliers 7-5
Fuel system 7-5, 10-10, 11-12
Fuel system 11-12
Fueling 7-5, 7-6
Fuses 10-6

G

Galvanic corrosion 11-4



Anodes 11-4, 12-2
 Gator Tough Deluxe Jon typical
 deck layout9-20
 Gator Tough Deluxe Jon typical
 helm layout9-18
 Gauges/Instruments10-3
 Gelcoat11-13
 General care and maintenance ...11-1
 General cleaning and
 maintenance11-12
 Getting underway7-10
 Glossary of nautical terms14-1
 Good boating practices2-2
 Gross Vehicle Weight Rating
 (GVWR)8-2
 Guidelines for participants in the
 water2-36

H

Harbor flags and indicators5-5
 Hardware, fasteners and
 fittings11-7
 Hazard2-6, 5-2, 5-4
 Hazard information2-32
 Helm7-11
 Hitch ball and trailer coupler8-3
 Horn6-4
 Horn switch10-4
 Hull11-13
 Hull identification number1-3
 Hull identification, capacity and
 safety plates1-3
 Hurricane and severe weather
 preparedness4-9
 Hydraulic steering system
 (if equipped)10-5
 Hypothermia4-1, 5-2

I

Icy waters5-2
 Inclement weather5-2
 Individual safety labels9-3
 Insurance3-2
 Isolated danger markers6-12

K

Knowing the boat2-30

L

Lateral markers6-10
 Launching8-9
 Law of salvage4-8
 Legal considerations8-1
 Life jackets2-14, 2-17, 11-2
 Lifting12-1
 Lighthouses6-8
 Lights2-25, 6-7, 6-13
 Lights and lighted structures6-7
 Limitations on who may operate
 the boat2-2
 Lines and knots7-23
 Livewell system without
 recirculation10-12
 Livewell systems10-11
 Loading guidelines8-11
 Locking swivel fishing seats10-14
 Locking swivel fishing seats with
 friction control10-14

M

Maintenance11-1, 11-12
 Man Overboard (MOB)4-4
 Manatee6-11
 Marine Assistance Request
 Broadcast (MARB)4-2
 Marine growth11-13
 Markers6-5, 6-8, 6-11
 Markers, warnings and
 advisories5-4
 Mayday4-2
 Medical emergencies4-1
 Meeting head-on6-3
 Mildew11-14
 Minimum onboard safety
 equipment2-14
 Minor lights6-7, 6-10
 Minors3-3
 Monofilament fishing line3-6
 Mooring7-20
 Mooring and trailering covers ...11-18



Mooring buoys 6-6

N

National Association of State Boating Law Administrators 1-6
 National Marine Manufacturers Association 1-6
 National Oceanic and Atmospheric Administration's National Weather Service 1-6
 National Safe Boating Council Inc. 1-6
 Nautical terminology 1-2
 Naval vessel protection zones 3-5
 Navigation lights 2-14
 Navigation lights switch 10-4
 Navigation markers 5-4
 Navigation rules and aids 6-1
 Navigational lights 2-25
 Navigational lights and night operation 6-13
 Negligent operation 3-4
 Neutral start safety switch 10-1
 Noise 3-7
 Non-skid flooring 11-17

O

Observer 2-35
 Occupant seating 2-40
 Onboard charger 11-11
 Operating in hazardous conditions 5-1
 Operating the boat 7-1
 Operating under the influence 3-3
 Operation by minors 3-3
 Operator's license and education 3-3
 Organizations 1-5
 Other special signs and markers 6-11
 Outboard engine fueling considerations 7-9
 Overtaking/passing 6-4

P

Paints 3-9

Passengers 7-10
 People with handicaps and elderly people 2-31
 Performance 7-4
 Personal location beacon (PLB) 2-29
 Pets 2-31
 Planing 7-14
 Platform dragging 2-33
 Platform/Boarding ladder 2-39
 Pole Anchor 10-16
 Power switch 10-4
 Power trim 7-15
 Pre-departure safety checklist 7-2
 Preferred channel markers 6-12
 Pregnant women 2-31
 Protecting the boat from theft 4-9
 Protecting the environment 3-8
 Publications 1-5

R

Range lights 6-7
 Range markers 6-9
 Re-boarding 2-39
 Recommended safety equipment 2-27
 Reduced visibility 5-2
 References and contact information 1-5
 Refueling 7-8
 Refueling built-in fuel tanks 7-9
 Registration 3-2
 Registration certificates 3-2
 Registration numbers 3-2
 Regulations ... 2-14, 3-3, 3-7, 3-9, 6-1
 Regulatory markers 6-8
 Repairs and modifications 11-1
 Reporting accidents 3-2, 4-6
 Reporting safety defects 8-12
 Requesting assistance (non-distress call) 4-2
 Required boating safety equipment and regulations 2-14
 Restricted areas 3-5
 Right-of-way 6-1

- Rotational thrust 7-12
 Rules of the road 6-1
 Running aground 4-5
- S**
- Sacrificial anodes 11-6
 Safe water markers 6-11
 Safety 2-1, 3-1, 7-2, 7-4
 Safety and training 2-6
 Safety chains 8-4
 Safety equipment 2-14, 2-27, 7-1, 11-2
 Safety guidelines 2-2
 Safety information 2-1
 Safety labels 2-6
 Safety labels and layouts 9-1
 Safety precautions 2-8
 Safety standards 1-3
 Safety statements 2-7
 Safety systems 10-20
 Saltwater corrosion 11-5
 Maintenance 11-5
 Sea Tow Services
 International, Inc. 1-6
 Seals in the engine lower unit 3-6
 Security zones 3-5
 Severe weather 5-1
 Shallow water 5-3
 Shallow water boat stability 3-7
 Shallow water operation 5-3
 Shift controls 10-1
 Shifting 7-12, 10-1, 10-2
 Shock 5-2
 Show lighting 2-26
 Signs 6-11
 Single-lever controls - single or twin engine 10-1
 Situational awareness 2-29
 Small boats and swimmers 2-30
 Sonar fishfinder and depthsounder (if equipped) 10-4
 Special markers 6-9
 Special needs passengers 2-30
 Speed 3-7
 Speed limits 3-7
- Speedometer 10-3
 Spillways 5-3
 Sportsman typical deck layout 9-8
 Sportsman typical helm layout 9-6
 Spotter 2-35
 Stainless steel and chrome hardware 11-21
 Starting 7-10
 Static electricity and the fuel system 7-5
 Steering 7-11
 Steering system 10-5, 11-12
 Stopping 7-12
 Storage 12-2–12-5
 Storing 12-1
 Storm conditions 5-1
 Storm warning 5-4
 Strong points 2-6
 Summer storage 12-4
 Surge brakes 8-5
 Switches 10-4
 Swivel/Slider seats 10-15
- T**
- Tachometer 10-3
 Teak 11-20
 The general prudential rule 6-1
 Throttle 10-1, 10-6
 Thru-hull fittings 12-2
 Tilt steering latch 10-5
 Toddlers 2-30
 Towing 4-7
 Towing hitch 8-2
 Towing on the water 4-7
 Towing vehicle 8-2
 Trailer 8-1, 11-20
 Trailer brakes 8-5
 Trailer classification 8-1
 Trailer gross vehicle weight rating 8-2
 Trailer regulations 8-1
 Trailer type 8-1
 Trailering and launching 8-1
 Trailering covers 11-18
 Trailering guidelines 8-6



Transom saver 10-16
 Trim and tilt 7-18
 Trim gauge (if equipped) 10-4
 Trim/Tilt switch 7-18
 Troubleshooting 13-1
 Turboswing tow bar 10-18
 Type B fire extinguishers 2-16

U

U.S. Coast Guard (USCG) 1-6, 3-1
 U.S. Coast Guard Auxiliary 1-6
 U.S. Coast Guard Minimum
 On-Board Personal Safety
 Equipment Required 2-14
 U.S. Coast Guard Navigation
 Center (NAVCEN) 1-6
 U.S. Coast Guard Office of
 Boating Safety 1-6
 U.S. Coast Guard safety s
 tandards compliance plate 1-3
 U.S. Coast Guard’s America’s
 Waterway Watch Program 1-6
 U.S. Government Publishing
 Office 1-7
 U.S. Power Squadrons 1-7
 United States Aids to Navigation
 System (USATONS) 6-5
 Upholstery 11-14
 USB charging port 10-17
 USCG safety standards 1-3
 Using distress signals 4-1

V

Vegetation 5-3
 Vehicle towing hitch 8-2
 Very high frequency (VHF)
 radio 2-28
 Vinyl care and cleaning guide ... 11-15
 Vinyl upholstery 11-14
 Visibility 5-2
 Visual distress signaling (VDS)
 devices 2-14, 2-22
 Visual distress signals (VDS) 2-24
 Voltmeter (if equipped) 10-4

W

Wake 3-7
 Walk-through windshield 10-17
 Washing 11-13, 11-14
 Water hazards 5-2
 Water sports 2-32
 Water sports guidelines 2-34
 Water sports hand signals 2-35
 Water Sports Industry
 Association 1-7
 Weather 4-6, 4-9, 5-1, 5-2
 Whistle 6-4
 Window channels 11-20
 Windshield 11-18
 Winterization and storage 12-1
 Winterizing 12-1
 Winterization and storage
 preparation 12-2



This document contains many of G3's valuable trademarks. It may also contain trademarks belonging to other companies. Any references to other companies or their products are for identification purposes only, and are not intended to be an endorsement.

© 2023 G3 Boats, a division of Skeeter Products, Inc. All rights reserved. G3 Boats reserves the right to change products and specifications without notice. All material in this manual is believed to be correct at the time of publication. Some optional equipment may be shown in some photographs.

Boat smart from the start, take a boating safety course and get a free vessel safety check annually for your boat. For more information, contact United States Coast Guard at www.uscgboating.org or United States Power Squadrons, 888-for-usps. Follow all instructional materials and local and federal laws. Remember to always observe all applicable boating laws. Never drink and drive.

Dress properly with a USCG approved personal flotation device and protective gear.

Always use your stop switch lanyard. Operate within your capabilities, allowing extra time and distance for maneuvering. Always operate in a responsible manner, respecting the environment and others around you.



MY AUTHORIZED G3 DEALER

Visit us at g3boats.com